

## Classic Round Series — RSL Post-Top Mount

The contemporary shape of the RSL pole top or side mounted lights make them an attractive choice for a variety of locations including pathways, parking lots, bikeways, and public spaces. These LED luminaires are solar powered and integrate the latest solar panel and battery technologies into the fixture for a sleek look. FLT's proprietary Adaptive Intelligence ensures continuous illumination throughout the night regardless of weather conditions or geographic location. With no need to trench or pull electrical wiring, RSL is an elegant, extraordinarily cost-effective solution.

### Benefits & Features:

- No wiring, trenching, or electrical service required
- Integrated design eliminates visually distracting external solar panels
- Cost-effective design ships fully assembled and installs in minutes
- No ongoing maintenance
- Provides programmed illumination all night, every night

### Key Applications:

- Area, Pathway, Plaza, Parking Lot, Perimeter Security



### Technical Specifications

- |              |                                                                                                                                                                                                                                               |
|--------------|-----------------------------------------------------------------------------------------------------------------------------------------------------------------------------------------------------------------------------------------------|
| Solar Panels | <ul style="list-style-type: none"> <li>• Industry's most efficient solar panel technology</li> <li>• Integrated into the top of luminaire</li> <li>• Active cell technology optimizes power generation even when partially blocked</li> </ul> |
|--------------|-----------------------------------------------------------------------------------------------------------------------------------------------------------------------------------------------------------------------------------------------|

- |         |                                                                                                                                                                                                                                                         |
|---------|---------------------------------------------------------------------------------------------------------------------------------------------------------------------------------------------------------------------------------------------------------|
| Battery | <ul style="list-style-type: none"> <li>• High performance Lithium Iron Phosphate (LiFePO4) technology</li> <li>• Exceptional 10+ year lifecycle</li> <li>• High and low temperature tolerance</li> <li>• Integrated within luminaire housing</li> </ul> |
|---------|---------------------------------------------------------------------------------------------------------------------------------------------------------------------------------------------------------------------------------------------------------|

- |                         |                                                                                                                                                                                                                                                                                                                                                                                                                                                                          |
|-------------------------|--------------------------------------------------------------------------------------------------------------------------------------------------------------------------------------------------------------------------------------------------------------------------------------------------------------------------------------------------------------------------------------------------------------------------------------------------------------------------|
| LED Engine & Controller | <ul style="list-style-type: none"> <li>• 100,000-hour LED L70 lifetime</li> <li>• CCT Options: 2700K, 3000K, 4000K</li> <li>• Dark Sky approved for 2700K, 3000K, and Amber</li> <li>• Wildlife friendly, narrow-band Amber LEDs (595nm)</li> <li>• High-efficiency, Maximum Power Point Tracking (MPPT) battery charger</li> <li>• High-efficiency integrated LED driver</li> <li>• Integrated optics maximize application efficiency and light distribution</li> </ul> |
|-------------------------|--------------------------------------------------------------------------------------------------------------------------------------------------------------------------------------------------------------------------------------------------------------------------------------------------------------------------------------------------------------------------------------------------------------------------------------------------------------------------|

- |                     |                                                                                                                                                                                                                                                                                   |
|---------------------|-----------------------------------------------------------------------------------------------------------------------------------------------------------------------------------------------------------------------------------------------------------------------------------|
| Optical Performance | <ul style="list-style-type: none"> <li>• High-efficiency type II, III, IV, and V full cutoff optics</li> <li>• Optional backlight shield</li> <li>• Achieves pathway and area lighting standards with typical output of 3250 lumens</li> <li>• B1 – U0 – G1 BUG Rating</li> </ul> |
|---------------------|-----------------------------------------------------------------------------------------------------------------------------------------------------------------------------------------------------------------------------------------------------------------------------------|

- |                       |                                                                                                                                                                                                                                                                                           |
|-----------------------|-------------------------------------------------------------------------------------------------------------------------------------------------------------------------------------------------------------------------------------------------------------------------------------------|
| Adaptive Intelligence | <ul style="list-style-type: none"> <li>• Intelligently manages lighting performance based on environmental conditions and lighting requirements</li> <li>• On-board multi-year data logging</li> <li>• Microcontroller-based technology</li> <li>• Equipped for motion sensing</li> </ul> |
|-----------------------|-------------------------------------------------------------------------------------------------------------------------------------------------------------------------------------------------------------------------------------------------------------------------------------------|

- |           |                                                                                                                                                                                                                       |
|-----------|-----------------------------------------------------------------------------------------------------------------------------------------------------------------------------------------------------------------------|
| Materials | <ul style="list-style-type: none"> <li>• Rugged die-cast aluminum</li> <li>• Stainless fasteners</li> <li>• Architectural grade, durable, TGIC powder coat</li> <li>• Standard and custom colors available</li> </ul> |
|-----------|-----------------------------------------------------------------------------------------------------------------------------------------------------------------------------------------------------------------------|

- |            |                                                                                                                                                                                                          |
|------------|----------------------------------------------------------------------------------------------------------------------------------------------------------------------------------------------------------|
| Mechanical | <ul style="list-style-type: none"> <li>• Yoke Mount option allows for easy installation</li> <li>• Various pole height options are available</li> <li>• Pre-drilled for seamless installation</li> </ul> |
|------------|----------------------------------------------------------------------------------------------------------------------------------------------------------------------------------------------------------|

- |                        |                                                                                                                                                                                                                     |
|------------------------|---------------------------------------------------------------------------------------------------------------------------------------------------------------------------------------------------------------------|
| Reliability & Warranty | <ul style="list-style-type: none"> <li>• Tested for High- &amp; Low- heat and humidity</li> <li>• 5-year warranty</li> <li>• 10+ year battery life</li> <li>• Designed and manufactured in North America</li> </ul> |
|------------------------|---------------------------------------------------------------------------------------------------------------------------------------------------------------------------------------------------------------------|

- |                   |                                                                                                                                                                              |
|-------------------|------------------------------------------------------------------------------------------------------------------------------------------------------------------------------|
| Lighting Profiles | <ul style="list-style-type: none"> <li>• 11 standard duration profiles available—pre-programmed or field adjustable</li> <li>• Custom, time-based profile options</li> </ul> |
|-------------------|------------------------------------------------------------------------------------------------------------------------------------------------------------------------------|

# Order Matrix

Series	Mounting	Finish	Optic	Distribution	LED	Lighting Profiles	Options
RSL	PTM - Post Top Mount	BK - Black	ST - Standard	Type II	2700K	00 - On at dusk > Off at dawn	SEC - Security Fasteners
		BZ - Bronze		Type III	3000K	01 - On at dusk > Off after 6 hours	MSO - Motion Sensor Off
		SV - Silver		Type IV	4000K	02 - On at dusk > Dim to 30% after 6 hours > Off at dawn	BLS - Backlight Shield
		WH - White		Type V	Amber	03 - On at dusk > Off after 5 hours > On 1 hour before dawn > Off at dawn	BLB - Blue Light Blocker
		CC - Custom				04 - On at dusk > Dim to 30% after 5 hours > Brighten to 100% 1 hour before dawn > Off at dawn	
						05 - On at dusk > Off after 3 hours	
						06 - On at dusk > Off after 4 hours	
						07 - On at dusk > Off after 4 hours > On 1 hour before dawn > Off at dawn	
						08 - Off (typically used with motion sensing)	
						09 (Default) - On at dusk > Dim to 30% after 3 hours > Brighten to 100% 1 hour before dawn > Off at dawn	
						10 - On 30% at dusk > Off at dawn	
						11 - Custom dusk - dawn - time-of-day profile	

Additional pole heights available.

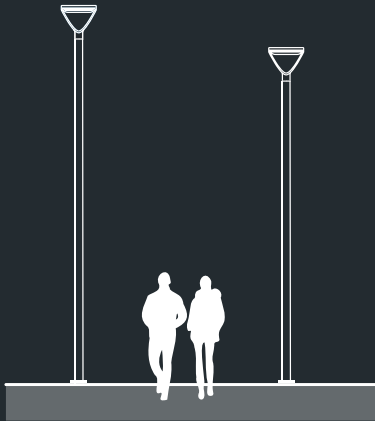

Solar Engine EPA:  
0.52 FT<sup>2</sup> (0.048 m<sup>2</sup>)

Solar Engine with Mount EPA:  
0.68 FT<sup>2</sup> (0.063 m<sup>2</sup>)

Luminaire Weight:  
41.04 lbs (18.62 kg)

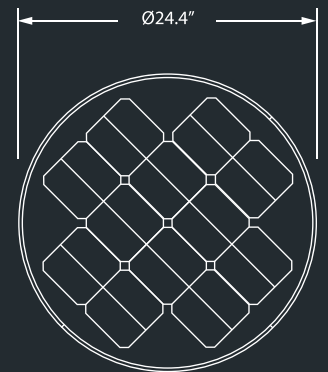
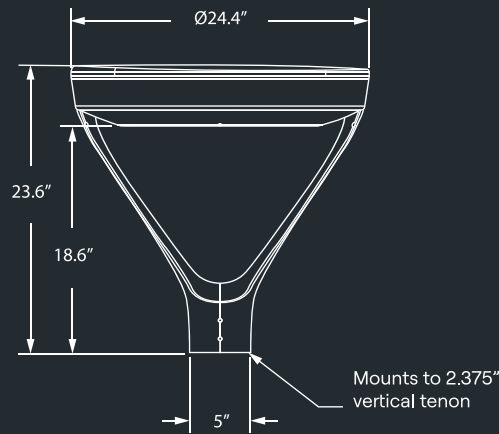

**FLT**



# Photometrics

## Type II

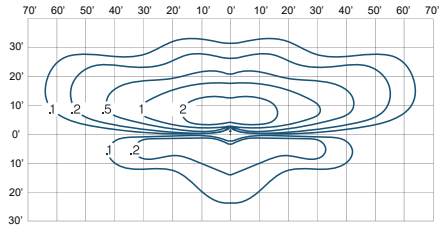

## Type III

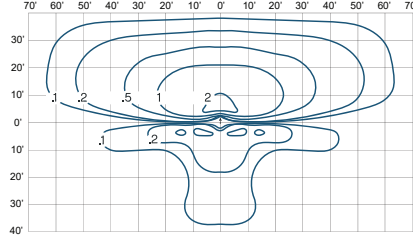

## Type IV

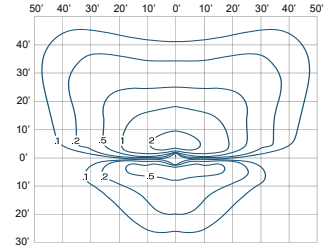

## Type V

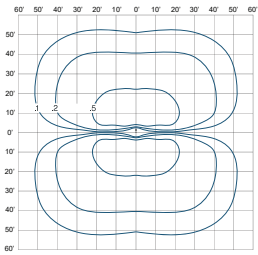

### Notes:

1. Photometrics based on 20 ft mounting height.
2. Light levels in foot candles are calculated using 3250 lumens at 4000K color temperature.
3. To convert to lux multiply light levels by 10.7.
4. Typical lumen levels based off of Type V optic with the default profile using neutral white LEDs.
5. Contact us for help in choosing the right lighting profile and distribution.
6. Motion sensing is ON by default.
7. Specifications subject to change without notice.
8. IES files available at FLT.com.