



Lync 5i

Pendant/Wall
BI-DIRECT
 Light Distribution



Integral Driver

Lync is a modern expression of lighting technology contained within a sleek and elegant form ideally suited for general illumination in office spaces.

- *Minimalistic planar profile*
- *Formed steel housing and fabricated aluminum end caps*
- *May be configured into individual fixtures or continuous runs*
- *The "Lync It" Latching System makes installing rows simple and intuitive in the field.*
- *Available in 3 standard paint finishes*
- *5 available lumen packages from 500 to 1300 lumens per ft**
*Refer to lumen charts for availability

Standard Individual Fixture Lengths

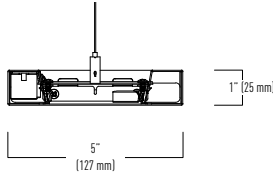
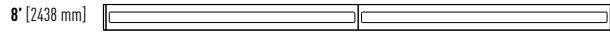
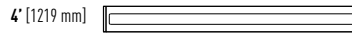

ORDERING INFORMATION / Example: LCP5i-30-FF-07-L35-FEC-UNV-DI-11-WH-T1WSC120-4

SERIES	SUB SERIES	WIDTH	LIGHT DISTRIBUTION	DIRECT SHIELDING	LUMEN PACKAGE	CRI & CCT	END CAP OPTIONS	
LC - Lync Minimalistic planar profile	P - Pendant Mount, Integral Driver W - Wall Mount, Integral Driver S - Surface Mount, Integral Drive	5i - 5" Profile (Integral)	20 - 20% Downlight, 80% Uplight	SBLB - Straight Blade Louver Black SBLW - Straight Blade Louver White	05 - 500 lm/ft 07 - 700 lm/ft 09 - 900 lm/ft 11 - 1100 lm/ft 13 - 1300 lm/ft	L - 80 CRI H - 90 CRI	30 - 3000K 35 - 3500K 40 - 4000K	FEC - Flat End Cap CEC - Curved End Cap REC - Rounded End Cap AEC - Angled End Cap
			30 - 30% Downlight, 70% Uplight	ASYM - Asymmetric Lens				
			50 - 50% Downlight, 50% Uplight	FF - Frosted Flush Lens				
			70 - 70% Downlight, 30% Uplight	35B - 35° Spot Black Baffle (100 Only)				
			100 - 100% Downlight	35W - 35° Spot White Baffle (100 Only)				

VOLTAGE	DRIVER	CIRCUITING	FINISH
UNV - Universal 120 - 277V 120V - 120V 277V - 277V	Dimming 0-10V DI - Dim to 1% (Standard) Integral Driver	Qty of Power Circuits Qty of Control Circuits 1 - 1 Power 1 - 1 Control	CC - Custom Color WH - White BK - Black SV - Silver

MOUNTING

Ceiling Type

- T1 - Aircraft Cable to 1" Grid
- T9 - Aircraft Cable to 9/16" Grid
- TS - Aircraft Cable to Slotted Grid
- SR - Aircraft Cable to Structure
- RR - Surface Mount
- WA - Wall Mount

Mounting Hardware Finish

- W - White Canopies and Cord
- B - Black Canopies and Cord

Standard Suspension Type

- SC - Standard Aircraft Cable

Suspension Length

- 048 - 48" Adjustable Aircraft Cable
- 120 - 120" Adjustable Aircraft Cable
- 240 - 240" Adjustable Aircraft Cable

CONNECTOR STYLE

- L-FCS - L-Shape Flat Connector Style
- L-CCS - L-Shape Curved Connector Style
- L-ACS - L-Shape Curved Connector Style
- TSC - T-Shape Connector
- YSC - Y-Shape Connector
- XSC - X-Shape Connector

LINEAR ROWS

- 4 - 48"
- 8 - 96"
- XX - Specify continuous run lengths in 4' increments

PHOTOMETRICS

*LUMEN OUTPUT VARIES. 3500K / 80 CRI USED FOR TEST RESULTS. CONSULT FACTORY FOR LUMEN PACKAGES ABOVE 1300 LM/FT.

*COLOR TEMP PERCENTAGE CHANGES, REFER TO IES FILE FOR ACTUAL VALUES

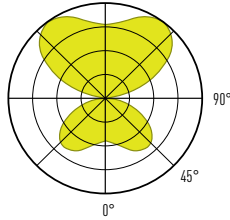

30 - 30% Downlight, 70% Uplight - (FF)			
PACKAGE	Lumens per ft	Watts per ft	Lumens per watt
05	483	4.1	119
07	696	6.0	116
09	907	8.0	113
11	1116	10.1	111
13	1282	11.6	111

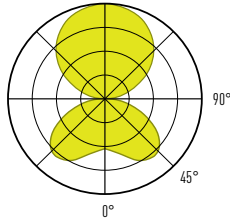

50 - 50% Downlight, 50% Uplight - (FF)			
PACKAGE	Lumens per ft	Watts per ft	Lumens per watt
05	501	4.4	113
07	703	6.4	110
09	903	8.4	107
11	1102	10.5	105
13	1300	12.4	105

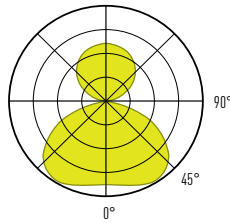

70 - 70% Downlight, 30% Uplight - (FF)			
PACKAGE	Lumens per ft	Watts per ft	Lumens per watt
05	510	4.8	106
07	700	6.8	103
09	888	8.8	100
11	1113	11.3	99
13	1298	13.1	99

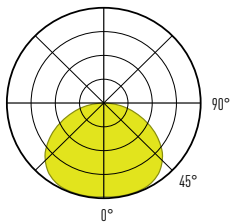

100 - 100% Downlight - (FF)			
PACKAGE	Lumens per ft	Watts per ft	Lumens per watt
05	493	5.2	94
07	697	7.8	90
09	900	10.1	89
11	1100	12.4	89

PHOTOMETRICS

*LUMEN OUTPUT VARIES. 3500K / 80 CRI USED FOR TEST RESULTS. CONSULT FACTORY FOR LUMEN PACKAGES ABOVE 1300 LM/FT.

*COLOR TEMP PERCENTAGE CHANGES, REFER TO IES FILE FOR ACTUAL VALUES

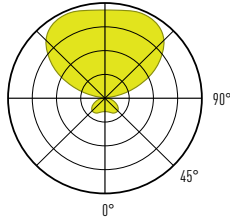

20 - 20% Downlight, 80% Uplight - (SBLB)			
PACKAGE	Lumens per ft	Watts per ft	Lumens per watt
05	496	4.8	103
07	718	7.2	100
09	901	9.3	97
11	1083	11.3	96
13	1300	13.4	97

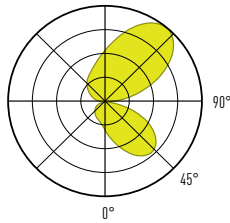

30 - 30% Downlight, 70% Uplight - (ASYM)			
PACKAGE	Lumens per ft	Watts per ft	Lumens per watt
05	521	4.1	128
07	704	5.6	126
09	885	7.26	123
11	1108	9.3	120
13	1284	10.9	118

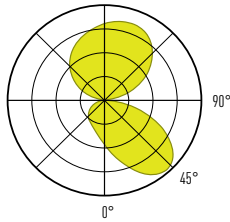

50 - 50% Downlight, 50% Uplight - (ASYM)			
PACKAGE	Lumens per ft	Watts per ft	Lumens per watt
05	500	4.1	123
07	720	6.0	120
09	894	7.8	115
11	1108	9.7	114
13	1318	11.6	114

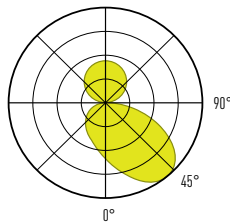

70 - 70% Downlight, 30% Uplight - (ASYM)			
PACKAGE	Lumens per ft	Watts per ft	Lumens per watt
05	511	4.4	115
07	716	6.4	112
09	918	8.4	109
11	1117	10.5	107
13	1313	12.4	106

PHOTOMETRICS

*LUMEN OUTPUT VARIES. 3500K / 80 CRI USED FOR TEST RESULTS. CONSULT FACTORY FOR LUMEN PACKAGES ABOVE 1300 LM/FT.

*COLOR TEMP PERCENTAGE CHANGES, REFER TO IES FILE FOR ACTUAL VALUES

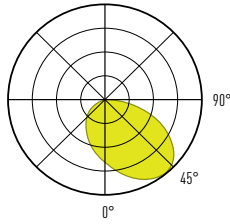

100 - 100% Downlight - (ASYM)			
PACKAGE	Lumens per ft	Watts per ft	Lumens per watt
05	490	4.8	102
07	707	7.2	98
09	886	9.3	96
11	1096	11.6	95

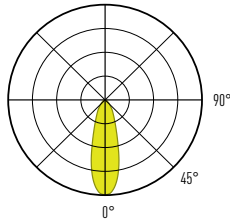

35B - 35° Spot Black Baffle			
PACKAGE	Lumens per ft	Watts per ft	Lumens per watt
05	301	2.24	134
07	500	4	126
09	798	6.9	116

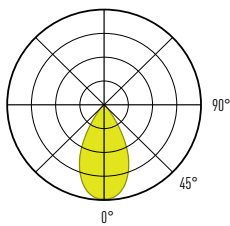

35W - 35° Spot White Baffle			
PACKAGE	Lumens per ft	Watts per ft	Lumens per watt
05	291	1.9	156
07	491	3.45	142
09	801	6.1	132

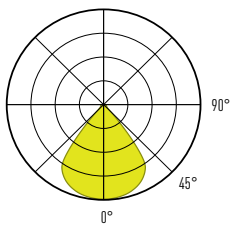

50B - 50° Flood Black Baffle			
PACKAGE	Lumens per ft	Watts per ft	Lumens per watt
05	295	2.1	143
07	504	3.8	133
09	797	6.4	125

50W - 50° Flood White Baffle			
PACKAGE	Lumens per ft	Watts per ft	Lumens per watt
05	308	2.1	149
07	504	3.45	138
09	810	6.1	129

80B - 80° Wide Flood Black Baffle			
PACKAGE	Lumens per ft	Watts per ft	Lumens per watt
05	305	2.42	126
07	494	4.16	119
09	796	7.31	109

80W - 80° Wide Flood White Baffle			
PACKAGE	Lumens per ft	Watts per ft	Lumens per watt
05	298	2.1	144
07	509	3.8	134
09	805	6.4	126

CROSS SECTIONS

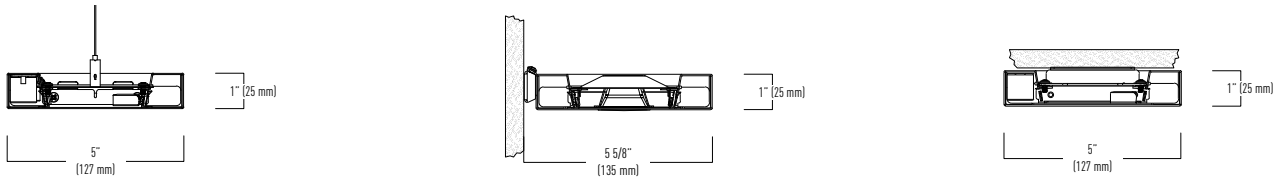

STANDARD END CAPS

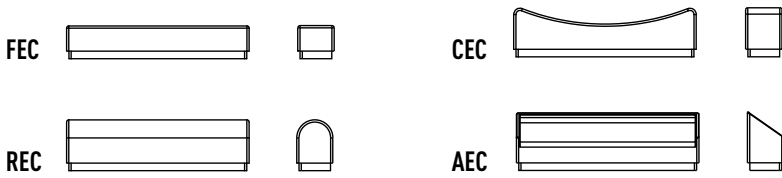

STANDARD CONNECTORS

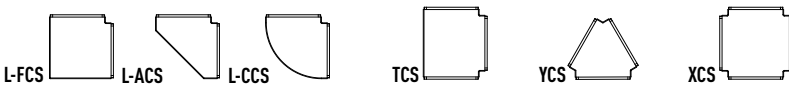

STANDARD SHAPES

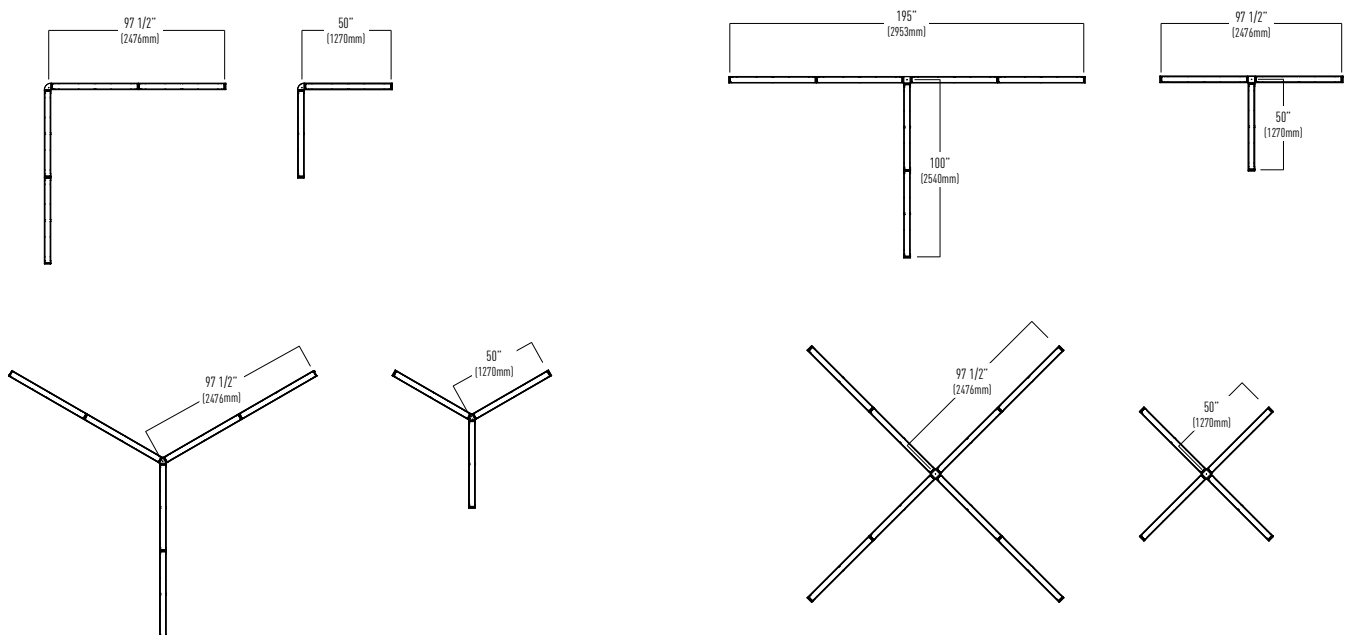

SHIELDING OPTIONS

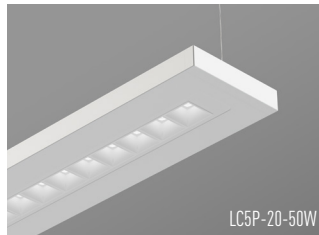
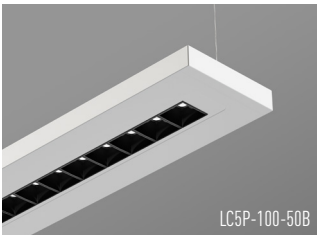
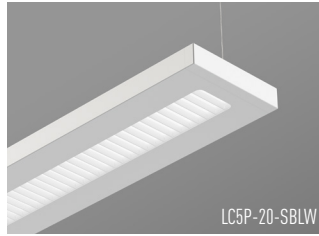
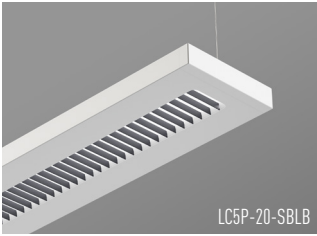

FIXTURE FINISH



The Lync Series is available in three standard fixture finishes and custom colors to create visually stunning lighting installations. These option carries an upcharge and additional lead time, consult your local sales agent for more information.

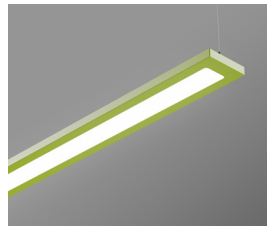

CC - Custom Color



WH - White



BK - Black Finish



SV - Silver Finish

PRODUCT SPECIFICATIONS AND INFORMATION

HOUSING CONSTRUCTION

Fixture body is constructed out of powder coat painted sheet 20 Ga steel with fabricated aluminum powder coat painted end caps. Captive joining mechanism is a combination die formed sheet metal and zinc plated spring steel. All hardware is stainless steel.

LEDS AND OPTICAL SYSTEM

Optical systems consist of a multiple rows of mid power constant current LEDs mounted to a removable highly reflective powder coated metal reflector. Frosted lens diffuses LED light source while delivering high efficacy general illumination.

STANDARD DIMMING LED DRIVERS

Standard constant current integral electronic 0-10v dimming input. Two standard driver options are available. Option **DI** dims to 1%

LIGHT OUTPUT

Standard factory set light outputs are programmed to within +/- 5% of the nominal light level at 3500K 80 CRI LEDs. Light output, wattage, and efficacy will vary across different CRI's CCT's. Refer to ies files on the website for actual detailed lighting performance data.

CIRCUITING

Each luminaire may have up to 1 line voltage (power) circuit and 1 low voltage (control) circuit.

Examples:

- "1-1"- 1 power circuit (Line Voltage) and 1 control circuit (Low Voltage) > 5 wires total (1 Black Wire "Hot", 1 White Wire "Neutral", 1 Green Wire "Ground", and 2 low voltage control wires, 1 Pink wire and 1 purple wire)

BATTERY PACKS

Recyclable Ni-Cad battery pack, battery run time is 90 minutes. Recharge time of 24 hours. 10W or 15W battery packs are available. To calculate Battery Lumen Output, multiply luminaire efficacy by battery wattage. (example: 120 lms/watt **(120)** x **B10** Battery Wattage **(10)** = **1200** lumens of egress illumination for 90 minutes.) Battery option not available in fixtures less than 4', and other limitations apply, consult factory. Entire "direct" fixture housing is energized by battery for lengths up to 5'. Half of direct fixture is energized by battery for 6' - 8' housing lengths. Emergency or night light circuit available (requires additional power circuit). Battery fixtures ship with an additional orange "constant hot" wire.

LUMEN MAINTENANCE

90% of initial light output (L90) at 100,000+ hours, 70% of initial light output (L70) at 200,000+ hours.

GENERATOR TRANSFER DEVICES

The GTD emergency lighting control device senses the loss of normal power and switches the AC driver input power connection to an unswitched, generator (or central inverter) supplied lighting circuit. GTD fixtures ship with 3 additional wires (orange wire "constant hot", black-red wire "generator hot", white-red wire "generator neutral").

FIXTURE FINISHES

Standard finish is powder coat painted white (**WH**), black (**BK**) or silver (**SV**). Consult factory for custom colors as these options can carry extended lead times and price adders.

INSTALLATION AND MOUNTING

Pendant luminaires mount to Acoustical Grid Ceilings (**T1,T9,TS**), Sheet Rock Ceilings and Various Structural Ceilings (**SR**). The product is suspended with adjustable aircraft cable up to 240" from ceiling surface. Luminaires may be individually mounted or continuously mounted in linear configurations or complex geometric patterns. Refer to data sheets and installation instructions for details on fixture dimensions, mounting location dimensions and available luminaire configurations.

Wall mounted (**WA**) luminaires are designed to mount to architectural wall surfaces, typically sheet rock frame-in construction. A rough-in junction box is required in addition to structural bracing within the wall for fixture support via factory provided mounting brackets. Wall mount, individual mount or continuous runs. Refer to installation instructions at www.nulite-lighting.com for details.

Surface mounted (**SR**) fixtures are designed to be surface mounted to an architectural building surface. The fixture must be secured to structure at specific locations along the fixture length and power must be also be roughed in at specific locations prior to installation. LCS may be individually mounted or continuously mounted in linear configurations or complex geometric patterns. Refer to installation instructions at www.nulite-lighting.com for details.

WARRANTY

5-year limited warranty on LED and driver from date of shipment. Refer to the full warranty details on <https://nulite.lighting/>.

WEIGHT

Fixtures are 3.50 lbs/ft, Driver box weights vary per enclosure type and electrical configuration, consult factory.

APPROVALS

ETL listed, conforms to UL Standard 1598 / 8750 and CSA Standard C22.2, indoor dry/damp locations.

TESTING AND CERTIFICATION

All of Nulite's LED components have been tested under **LM-80** guidelines ensuring 6000 hours of luminous flux data. Additionally Nulite can supply **LM-79** data on all luminaires. This data includes luminous flux, electrical power, efficiency, chromatically as well as the diffusion of luminous intensity.