

# Regolo IP65 Rated RXT-W-D



The RXT-W-D IP65 wet location rated linear lighting system brings the elegance of the Regolo product series into harsh outdoor environments where moisture, wind and dust can be an enemy to a light fixture.

- *Rugged three-sided .125" thick aluminum housing with affixed end caps.*
- *Housing standard finish is electrostatically applied textured white powder coat paint. Optional silver, black, or custom color paints finishes.*
- *IP65 rated exterior linear luminaire designed for demanding environments for protection against water, dust, oil, and bugs.*
- *Fully sealed gasketed lens and electrical fittings. Vandal resistant 1/4" thick lens has an 08 IK Rating with no exposed fasteners.*
- *Natorium finish standard.*

### Standard Individual Fixture Lengths

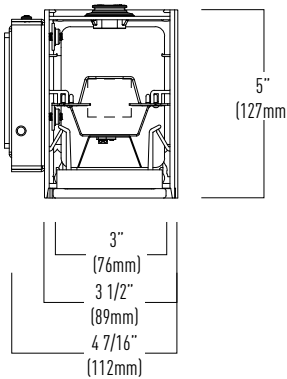
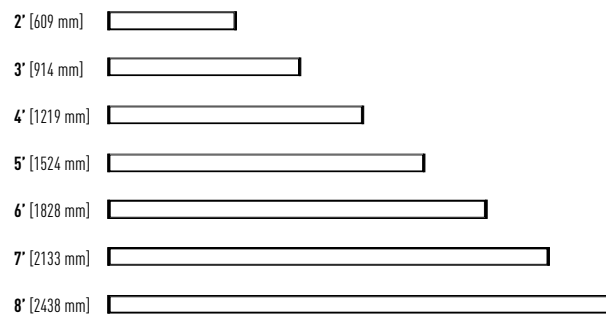

RXT-W-D / Frosted Flush Lens

### ORDERING INFORMATION / Example: RXT-W-D-FF-09-L35-UNV-D-11-WH-W-8

RXT	SUB SERIES	DIST	DIRECT SHIELDING	LUMENS DOWN	CRI/ CCT	VOLTAGE
RXT - Regolo 4" wide IP65 rated fixtures	W - Wall	D - Direct	FF - Flush Frosted ASYM - Asymmetric Lens	03 - ~300 lm/ft 05 - ~500 lm/ft 07 - ~700 lm/ft 09 - ~900 lm/ft 11 - ~1100 lm/ft 14 - ~1400 lm/ft	L - 80 CRI H - 90 CRI 30 - 3000K 35 - 3500K 40 - 4000K	UNV - Universal 120 - 277V 120V - 127V 277V - 277V 347V - 347V

\*Asymmetric Lens can't exceed ~900 lm/ft

DRIVER	CIRCUIT	FINISH	MOUNTING	LENGTH	OPTIONS
<b>Dimming 0-10V</b> D - Dim to 1% (Standard) Integral Driver DO - Dim to 1%, Fade to Off Integral Driver D02 - Eldoled Solodrive, Dim to 0% Integral Driver <b>DD DALI</b> ELE - Ecodrive - 1% ELS - Solodrive - 0% LUTRON - See options on page 3	<b>Qty of Power Circuits</b> 1 - 1 Power 2 - 2 Power <b>Qty of Control Circuits</b> 1 - 1 Control 2 - 2 Control <b>Emergency Options</b> B10 - 10 Watt Battery Pack (CEC Compliant) B15 - 15 Watt Battery Pack (CEC Compliant) GTD - Generator Transfer Device (120V or 277V) EM - Dedicated Emergency Circuit	CC - Custom Color WH - White BK - Black SV - Silver	<b>Type</b> W - Wall MR - Mullion Mount AR - Adjustable Arm Mount	2 - 2 ft 3 - 3 ft 4 - 4 ft 5 - 5 ft 6 - 6 ft 7 - 7 ft 8 - 8 ft XX- x ft	GLR - Fusing WLX - Wavelinx (Cooper Lighting Solutions) Integral Sensor NX - NX (Hubbel) Integral Sensor NLT - nLight (Acuity Brands) Integral Sensor LV - Vive (Lutron) Integral Sensor ENL - Enlighted Integral Sensor

\*Consult factory for sensor comparability.

**PHOTOMETRICS**

\*LUMEN OUTPUT MAY VARY. 3500K / 80 CRI USED FOR RESULTS.

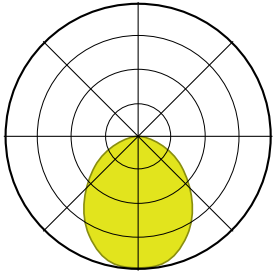

FRF - Frosted Flush Lens			
PACKAGE	Lumens per ft	Watts per ft	Lumens per watt
03	300	3.10	97
05	504	5.28	96
07	705	7.73	91
09	901	10.14	89
10	1013	9.97	102
12	1191	11.72	102
14	1369	13.44	101

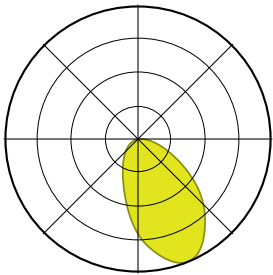

ASYM - Asymmetric Lens			
PACKAGE	Lumens per ft	Watts per ft	Lumens per watt
03	298	2.59	115
05	503	4.34	116
07	705	6.27	112
09	904	8.37	108

## DRIVER INFORMATION

NULITE CAT#	DRIVER MANUFACTURER / SERIES	DIMMING / CONTROL PROTOCOL	DIM RANGE	NOTES/ DESCRIPTION
D	Signify Xitanium, Osram OTI	0-10v	100% - 1%	Standard Nulite driver, base fixture price
D0	Signify Xitanium, Osram OTI	0-10v	100% - 1% (Steps from 1% to 0% or OFF)	Standard Nulite driver, base fixture price
D02	Eldoled Solodrive	0-10v	100% - 0%	Logarithmic Dimming Curve
L11	Lutron Hi-Lume Premier (PEQ0E) Max lumen package 03	0-10v	100% - 0.1%	Hi-Lume Premier 0.1% EcoSystem LED driver with Soft-on, Fade-to-Black dimming technology
L15	Lutron Hi-Lume Series (LDE1)	0-10v	100% - 1%	Hi-Lume 1% EcoSystem LED driver with Soft-on, Fade-to-Black dimming technology
ELE	Eldoled Ecodrive	DALI	100% - 1%	Logarithmic Dimming Curve
ELS	Eldoled Solodrive	DALI	100% - 0%	Logarithmic Dimming Curve

## FIXTURE FINISH



RXT is available in three standard powder coat painted finishes including White **(WH)**, Black **(BK)**, Silver **(SV)**, and Custom Color.



WH - White Finish



BK - Black Finish



SV - Silver Finish

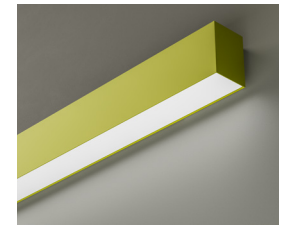

CC - Custom Color

## MOUNTING OPTIONS

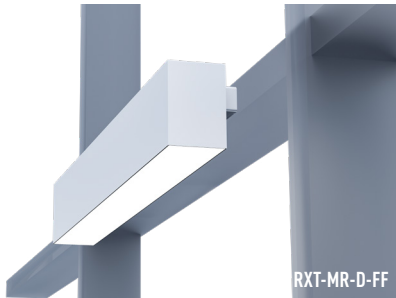

RXT-MR-D-FF

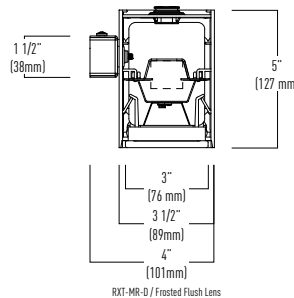

RXT-AR-D-FF

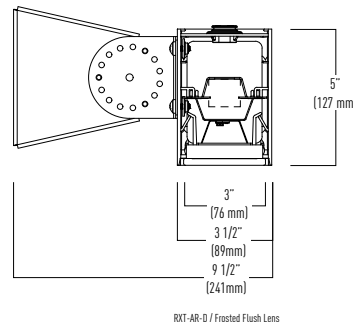

## SENSOR OPTIONS



## PRODUCT SPECIFICATIONS AND INFORMATION

### HOUSING CONSTRUCTION

The housing consists of rugged three-sided .125" thick aluminum housing with affixed end caps. Housing is IP65 rated exterior linear luminaire designed for demanding environments for protection against water, dust and oil. The fixture construction is natatorium appropriate standard.

### LEDS AND OPTICAL SYSTEM

Optical systems consist of a single row of mid power constant current LEDs mounted to a removable highly reflective powder coated metal reflector. Vandal resistant 1/4" thick lens has an IK rating of 08 with no exposed fasteners. Frosted lens diffuses LED light source while delivering high efficacy general illumination.

### STANDARD DIMMING LED DRIVERS

Standard constant current integral electronic 0-10v dimming input. Two standard driver options are available. Option **D** dims to 1% and option **DO** dims to 0% or OFF (the final 1 percent is a "step"). Both options are the same price and representative of the base fixture price. Options **D** and **DO** ship with 5 wires (Line Voltage- Black and White wires, Low Voltage- Purple and Pink wires, Ground- Green wire).

### DALI DRIVERS

Standard constant current DALI drivers available in either a dim to 1% (**ELE**) or dim to 0% (**ELS**). DALI fixtures ship with 5 wires (Line Voltage- Black and White wires, Low Voltage- Purple and Pink wires, Ground- Green wire).

### LIGHT OUTPUT

Standard factory set light outputs are programmed to within +/- 5% of the nominal light level at 3500K 80 CRI LEDs. Light output, wattage, and efficacy will vary across different CRI's CCT's. Refer to ies files on the website for actual detailed lighting performance data.

### CIRCUITING

Each luminaire may have up to 2 line voltage (Power) circuits and 2 low voltage (Control) circuits.

#### Examples:

- **"1-1"**- 1 power circuit (Line Voltage) and 1 control circuit (Low Voltage) > 5 wires total (1 Black Wire "Hot", 1 White Wire "Neutral", 1 Green Wire "Ground", and 2 low voltage control wires, 1 Pink wire and 1 Purple wire)
- **"2-2"**- 2 power circuits (Line Voltage) and 1 control circuit (Low Voltage) > 9 wires total (2 Black Wires "Hot", 2 White Wires "Neutral", 1 Green Wire "Ground", and 4 low voltage control wires, 2 Pink wires and 2 Purple wires)

### BATTERY PACKS

Recyclable Ni-Cad battery pack, battery run time is 90 minutes. Recharge time of 24 hours. Battery packs up to 15W are available. To calculate Battery Lumen Output, multiply luminaire efficacy by battery wattage. [example: 120 lms/watt (**120**) x **B10** Battery Wattage (**10**) = **1200** lumens of egress illumination for 90 minutes.] Battery option not available in fixtures less than 4', and other limitations apply, consult factory. Entire "direct" fixture housing is energized by battery for lengths up to 5'. Half of direct fixture is energized by battery for 6' - 8' housing lengths. Emergency or night light circuit available (requires additional power circuit). Battery fixtures ship with an additional Orange "constant hot" wire.

### LUMEN MAINTENANCE

90% of initial light output (L90) at 100,000+ hours, 70% of initial light output (L70) at 200,000+ hours calculated.

### GENERATOR TRANSFER DEVICES

The GTD emergency lighting control device senses the loss of normal power and switches the AC driver input power connection to an unswitched, generator (or central inverter) supplied lighting circuit. GTD fixtures ship with 3 additional wires (Orange wire "constant hot", Black-Red wire "generator hot", White-Red wire "generator neutral").

### FIXTURE FINISHES

Standard finish is powder coat painted white (**WH**), black (**BK**) or silver (**SV**). Consult factory for custom colors as these options carry extended lead times and price adders to cover set-up and material costs.

### INSTALLATION AND MOUNTING

RXT-W is designed to mount to architectural wall surfaces. A rough-in junction box is required in addition to structural bracing within the wall for fixture support via factory provided mounting brackets. Wall mount, individual mount or continuous runs. Refer to installation instructions at <https://nulite.lighting/> for details.

### WARRANTY

5-year limited warranty on LED and driver from date of shipment. Refer to the full warranty details on <https://nulite.lighting/>.

### WEIGHT

Fixtures are 6.25 lbs/ft. Driver box weights vary per enclosure type and electrical configuration, consult factory.

### APPROVALS

Vandal resistant 1/4" thick lens has an IK rating of 08 with no exposed fasteners. Fully sealed gasketed lens and electrical fittings. ETL listed, conforms to UL Standard 1598 and CSA Standard C22.2, indoor dry/wet locations.

### TESTING AND CERTIFICATION

All of Nulite's LED components have been tested under **LM-80** guidelines ensuring 6000 hours of luminous flux data. Additionally Nulite can supply **LM-79** data on all luminaires. This data includes luminous flux, electrical power, efficiency, chromaticity as well as the diffusion of luminous intensity.