

# Regolo Zero LA Series LPZERO-D

Pendant  
DIRECTIONAL  
Light Distribution



The Regolo Zero LA Series directional pendant mount creates ideal lighting conditions for a multitude of spaces. Offered in a sub 1-inch aperture utilizing a directional light distribution and various mounting options.

- **Sub 1" aperture optical assembly**
- **Available in 3 standard paint finishes and custom colors**
- **Discrete optical system offers two beam patterns 55° and 65°**
- **Tool free installation with the engineered NuLoc™ joining system**
- **Connect using mitered and pivot joints (Reference LZERO Shapes Specification Sheet) Configure into linear rows, complex patterns and individual geometric shapes**

### Standard Individual Fixture Lengths\*

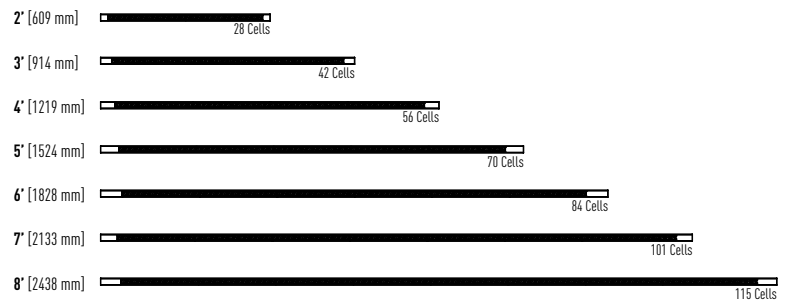

### ORDERING INFORMATION / Example: LPZERO-D-55B-08-H35-FEC-UNV-D-11-WH-T1WPC048-4

LPZERO					
SERIES	DISTRIBUTION	SHIELDING	LUMEN PACKAGE	CRI/ CCT	END CAPS
LPZERO - Regolo Zero LA Series 1" Wide, 1" Tall, Directional Remote Pendant Mount	D - Directional	55B - 55° Black Flood Baffle 55W - 55° White Flood Baffle 65B - 65° Black Flood Baffle 65W - 65° White Flood Baffle	04 - 400 lm/ft 07 - 700 lm/ft 09 - 900 lm/ft	H30 - 90 CRI, 3000K H35 - 90 CRI, 3500K H40 - 90 CRI, 4000K	FEC - Flat End Cap REC - Round End Cap SEC - Square Rotating End Cap

\*Fixture rows specified with Square Rotating End Caps (SEC) are joined together using the Pivot Joint (PJ) see details on page 3.

VOLTAGE	DRIVER (REMOTE)	CIRCUITING / EMERGENCY OPTIONS			FIXTURE FINISH
UNV - Universal 120V - 277V 120V - 120V 277V - 277V	<b>Dimming 0-10V</b> D - Dim to 1% (Standard) DO - Dim to 1%, Fade to Off DO2 - Eldoted Solodrive, Dim to 0% LUTRON - See options on page 2 <b>DALI Dimming</b> ELE - Eldoted Ecodrive, Dim to 1% ELS - Eldoted Solodrive, Dim to 0%	<b>Qty of Power Circuits</b> 1 - 1 Power	<b>Qty of Control Circuits</b> 1 - 1 Circuit	<b>Options (Remote)</b> B10 - 10 Watt Battery Pack (CEC Compliant) B14 - 14 Watt Battery Pack (CEC Compliant) B15 - 15 Watt Battery Pack (CEC Compliant) GTD - Generator Transfer Device (120V or 277V) EM - Dedicated Emergency Circuit	WH - White Painted Finish SV - Silver Painted Finish BK - Black Painted Finish CC - Custom Color Painted Finish

MOUNTING				LINEAR LENGTH
<b>Structure Type (Remote Driver Power Supply)</b> T1 - 1" Ceiling Grid, Aircraft Cable Suspension (Remote "Grid" Driver Enclosure) T9 - 9/16" Ceiling Grid, Aircraft Cable Suspension (Remote "Grid" Driver Enclosure) TS - Slot Ceiling Grid, Aircraft Cable Suspension (Remote "Grid" Driver Enclosure) GP - 5 5/8" Canopy Integrated Power Supply, for Inaccessible Ceilings or Grid ceilings	<b>Mounting Hardware Finish</b> W - White Canopies and Cord/Stem B - Black Canopies and Cord/Stem S - Silver Canopies and Stem (RS Only) CC - Custom Color Canopies and Stem (RS Only)	<b>Power Suspension Type</b> PC - Power Cord Suspension RS - Rigid Stem Suspension	<b>Suspension Length (Power Cord)</b> 048 - 48" Power Cord 120 - 120" Power Cord 240 - 240" Power Cord <b>Suspension Length (Rigid Stem)</b> 06 - 6" Rigid Stem 12 - 12" Rigid Stem	2 - 24" 3 - 36" 4 - 48" 5 - 60" 6 - 72" 7 - 84" 8 - 96" XX - Specify continuous run lengths in 1' increments

## PHOTOMETRICS

\*LUMEN OUTPUT MAY VARY. 3500K / 80 CRI USED FOR RESULTS.

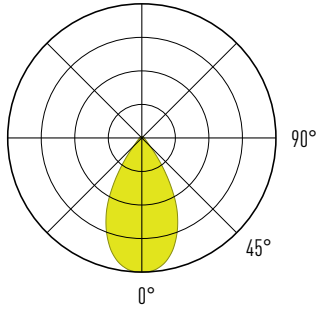

55B - 55° Black Flood Baffle			
PACKAGE	Lumens per ft	Watts per ft	Lumens per watt
04	403.9	3.841	105
07	707.7	7.636	93
09	905.1	9.659	94

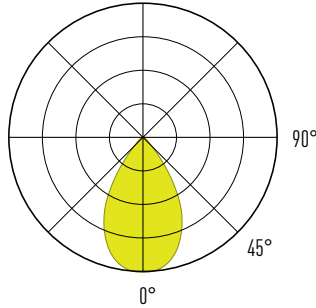

65B - 65° Black Flood Baffle			
PACKAGE	Lumens per ft	Watts per ft	Lumens per watt
04	401.5	3.246	124
07	703.4	5.790	121
09	912.1	8.009	114

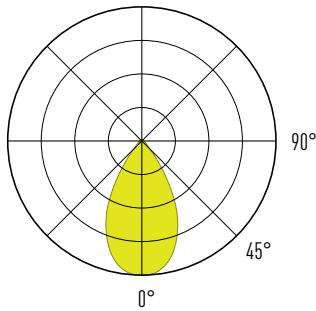

55W - 55° White Flood Baffle			
PACKAGE	Lumens per ft	Watts per ft	Lumens per watt
04	413.7	3.246	127
07	706.7	5.680	124
09	904.3	7.729	117

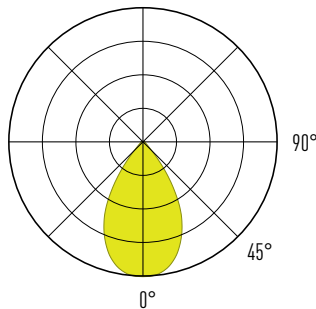

65W - 65° White Flood Baffle			
PACKAGE	Lumens per ft	Watts per ft	Lumens per watt
04	401.5	3.246	124
07	703.4	5.790	121
09	912.1	8.009	114

## DRIVER INFORMATION

NULITE CAT#	DRIVER MANUFACTURER / SERIES	DIMMING / CONTROL PROTOCOL	DIM RANGE	NOTES/ DESCRIPTION
D	Signify Xitanium, Osram OT1	0-10v	100% -1%	Standard Nulite driver, base fixture price
D0	Signify Xitanium, Osram OT1	0-10v	100% - 1% (Steps from 1% to 0% or OFF)	Standard Nulite driver, base fixture price
D02	Eldoled Solodrive	0-10v	100% - 0%	Logarithmic Dimming Curve
L11	Lutron Hi-Lume Premier (PEQ0E) Max lumen package 03	0-10v	100% - 0.1%	Hi-lume Premier 0.1% EcoSystem LED driver with Soft-on, Fade-to-Black dimming technology
L15	Lutron Hi-Lume Series (LDE1)	0-10v	100% - 1%	Hi-Lume 1% EcoSystem LED driver with Soft-on, Fade-to-Black dimming technology
ELE	Eldoled Ecodrive	DALI	100% - 1%	Logarithmic Dimming Curve
ELS	Eldoled Solodrive	DALI	100% -0%	Logarithmic Dimming Curve

**FIXTURE FINISH**

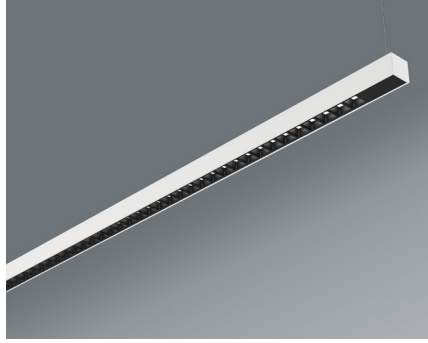

Regolo Zero LA Series is available in three standard powder coat painted finishes including White Painted Finish (**WH**), Silver Painted Finish (**SV**), Black Painted Finish (**BK**) and Custom Color Painted Finish (**CC**).

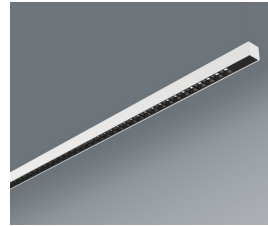

**WH** - White Painted Finish

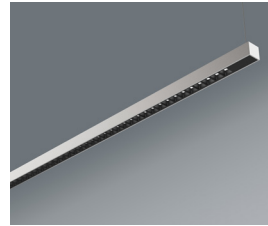

**SV** - Silver Painted Finish

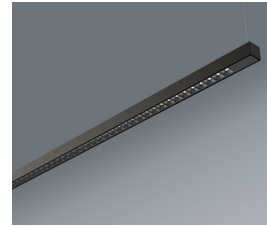

**BK** - Black Painted Finish

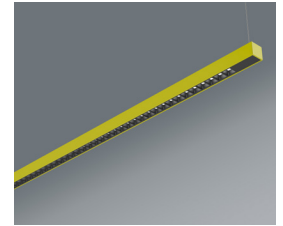

**CC** - Custom Color Painted Finish

**CROSS SECTIONS**

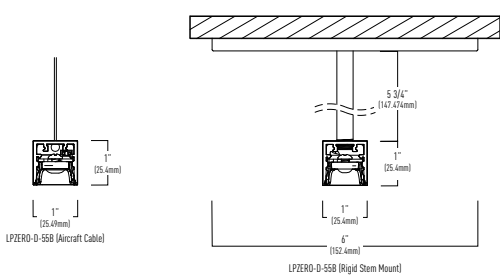

**SHIELDING**



55° Black Flood Baffle (55B)

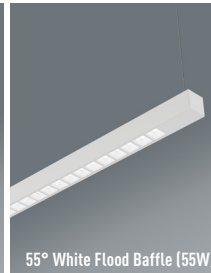

55° White Flood Baffle (55W)



65° Black Flood Baffle (65B)

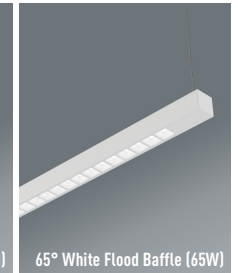

65° White Flood Baffle (65W)

**END CAPS**

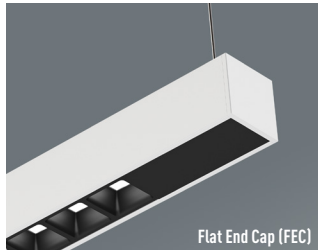

Flat End Cap (FEC)

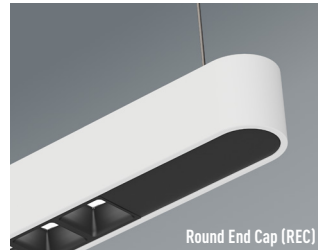

Round End Cap (REC)

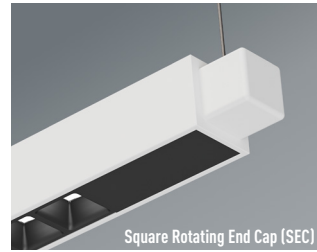

Square Rotating End Cap (SEC)

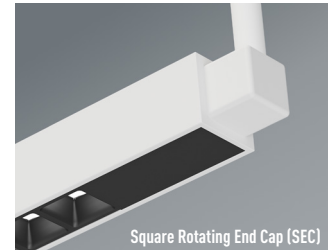

Square Rotating End Cap (SEC)

**SQUARE ROTATING END CAP AIMING DETAIL**

Freely adjust luminaires directional distribution with 359° of rotational tilt between mounting points. Secure desired beam angle using set screws.

**Square Rotating End Cap Example**

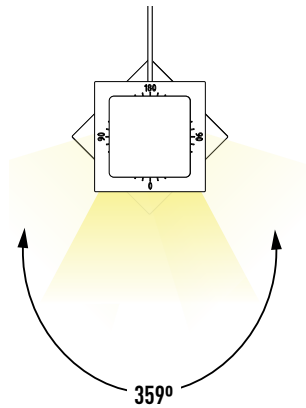
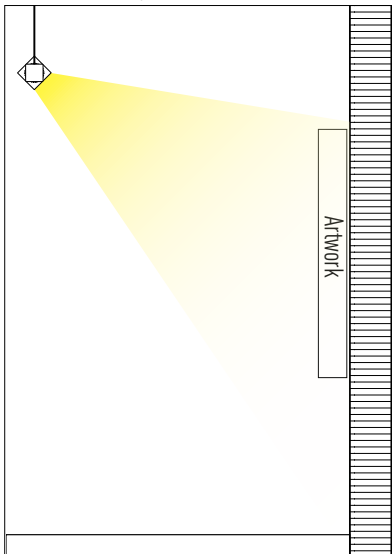

**PIVOT JOINT (PJ)**

Create continuous runs using the Pivot Joint. Each individual fixture configured into rows rotate independent between Square Rotating End Caps (**SEC**).

**Pivot Joint Continuous Row Example**

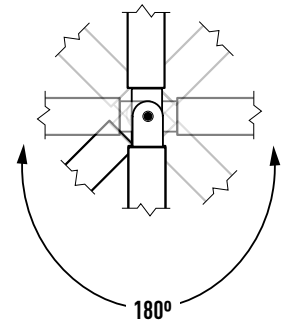
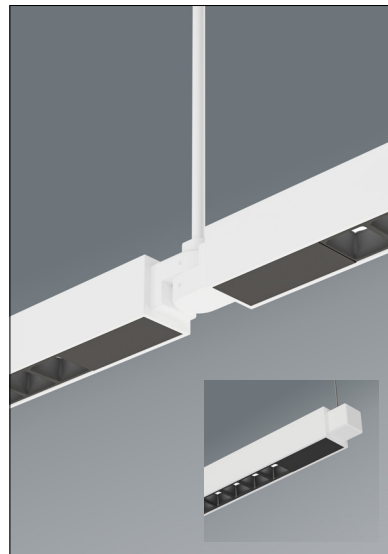



Introducing the latest in linear lighting innovation: Regolo Zero is Nulite's first fixture series to feature the groundbreaking NuLoc™ joining technology. This revolutionary design redefines how lighting fixtures connect and perform, offering unparalleled functionality and aesthetic appeal.

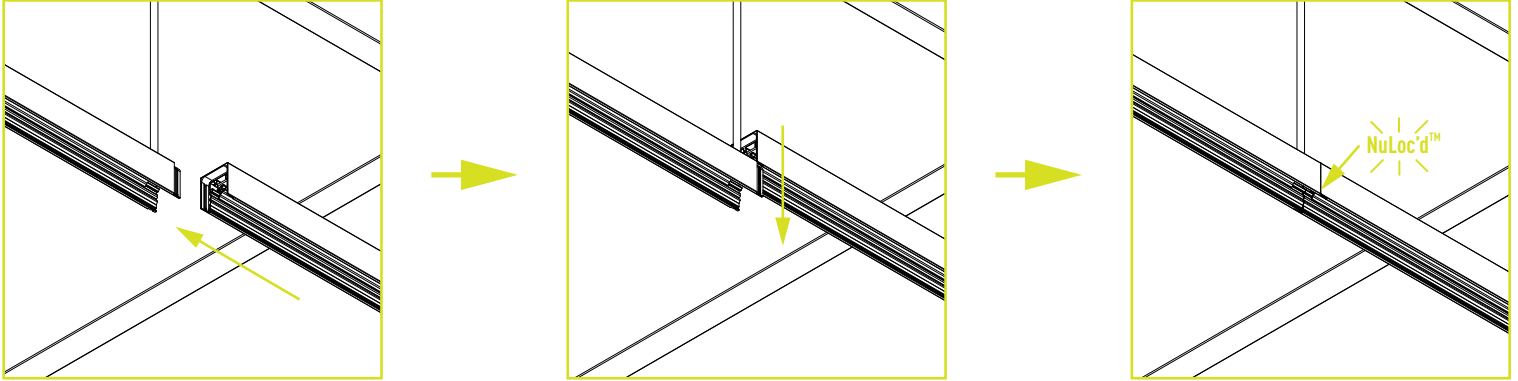

**Effortless Integration**

The innovative NuLoc™ system eliminates the need for hardware or tools, simplifying installation while preserving design integrity.

**Flawless Aesthetics**

Seamlessly connect fixtures for continuous runs, unique configurations, and intricate shapes, all without compromising light quality.

**Zero Light Leaks**

Achieve a monolithic appearance, uniform illumination with precision-engineered lensing for a polished, professional look.

## STANDALONE FIXTURE LENGTHS AND OPTIC ASSEMBLY LENGTHS DETAIL

Each optical assembly will be secured between extruded aluminum blanks. The length of each extruded aluminum blank is dependent on the overall specified fixture length and requested optics configurations. Contact factory for details regarding the overall linear length and the extruded aluminum blanks.

In order to specify standalone fixtures or fixture rows without extruded aluminum blanks, orders must be specified with custom linear lengths that accommodate the optic length.

For details regarding the differences between fixtures that don't utilize extruded aluminum lengths please contact the factory [cs@nulite.lighting](mailto:cs@nulite.lighting).

A Housing Length	B Optics Length	C Aluminum Cover Length
24"	22"	1"
36"	33"	1.5"
48"	44"	2"
60"	55"	2.5"
72"	66"	3"
84"	79 3/8"	2.3125"
96"	90 3/8"	2.8125"

### FIXTURE LENGTHS WITH ALUMINUM BLANKS DETAIL

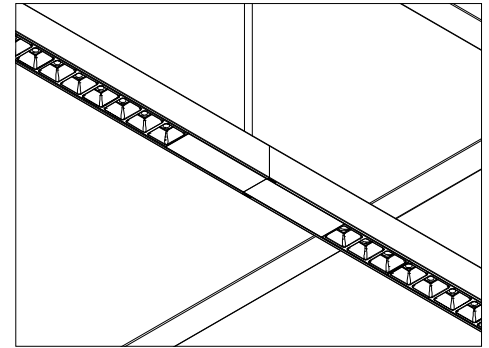
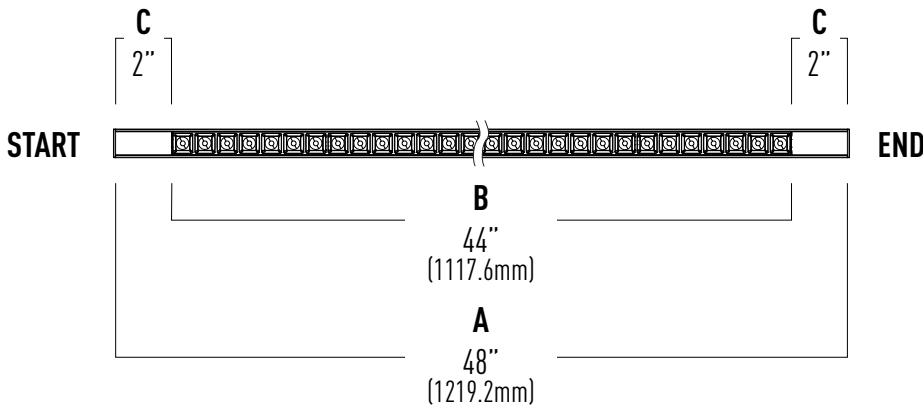

### FIXTURE LENGTHS WITHOUT ALUMINUM BLANKS DETAIL

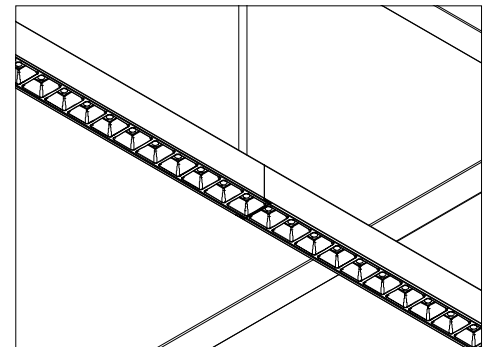
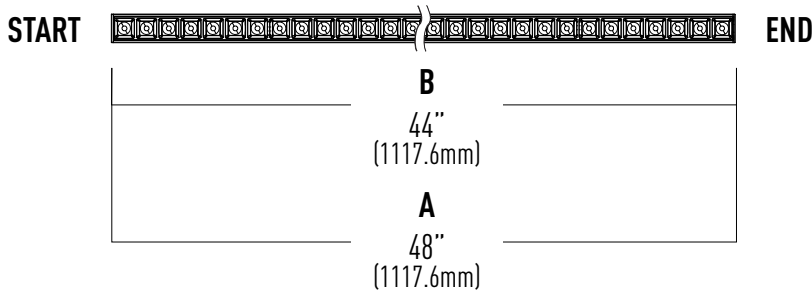

## PRODUCT SPECIFICATIONS AND INFORMATION

### HOUSING CONSTRUCTION

Luminaire housing is up to 70% recycled content constructed of extruded aluminum with machined aluminum or die cast zinc end caps. All hardware is stainless steel. Row and pivot joint components are machined or die cast aluminum.

Remote grid mounted driver enclosures (**T1/T9/TS**) and canopy integrated power supply (**GP**) are constructed out of die-formed galvanized steel.

### LEDS AND OPTICAL SYSTEM

Frosted Flush Lenses (**FF**) and Black Flush Lenses (**BF**) are co-extruded frosted acrylic with matte white reflector for even illumination.

Regolo Zero LA Series (**55B/55W/65B/65W**) low glare optic system offer beam patterns from 55°-65° and asymmetric distributions, utilizing optical grade acrylic TIR lenses.

### STANDARD DIMMING LED DRIVERS

Standard constant current remote electronic 0-10v dimming input. Two standard driver options are available. Option (**D**) dims to 1% and option (**DO**) dims to 0% or OFF (the final 1 percent is a "step"). Both options are the same price and representative of the base fixture price. Options (**D**) and (**DO**) ship with 5 wires (Line Voltage- Black and White Wires, Low Voltage- Purple and Pink Wires, Ground- Green Wire)

### DALI DRIVERS

Standard constant current DALI drivers available in either a dim to 1% (**ELE**) or dim to 0% (**ELS**). DALI fixtures ship with 5 wires (Line Voltage- Black and White Wires, Low Voltage- Purple and Pink Wires, Ground- Green Wire)

### LIGHT OUTPUT

Standard factory set light outputs are programmed to within +/- 5% of the nominal light level at 3500K 80 CRI LEDs. Light output, wattage, and efficacy will vary across different CRI's CCT's. Refer to ies files on the website for actual detailed lighting performance data.

### CIRCUITING

Each luminaire may have up to 2 line voltage (Power) circuits and 2 low voltage (Control) circuits. Two power circuits are required for independent control of left and right sections in linear luminaires, and low voltage control circuits are required for independent dimming of each circuit.

#### Examples:

- **"1-1"**- 1 power circuit (Line Voltage) and 1 control circuit (Low Voltage) > 5 wires total (1 Black Wire "Hot", 1 White Wire "Neutral", 1 Green Wire "Ground", and 2 low voltage control wires, 1 Pink Wire and 1 Purple Wire)
- **"2-2"**- 2 power circuits (Line Voltage) and 1 control circuit (Low Voltage) > 9 wires total (2 Black Wires "Hot", 2 White Wires "Neutral", 1 Green Wire "Ground", and 4 low voltage control wires, 2 Pink Wires and 2 Purple Wires)

### BATTERY PACKS

Maintenance free lithium ion battery pack, battery run time is 90 minutes. Recharge time of 24 hours. 10 Watt Battery Pack (**10W**) or 15 Watt Battery Pack (**15W**) are available. To calculate Battery Lumen Output, multiply luminaire efficacy by battery wattage. (example: 110 lms/watt (120) x B10 Battery Wattage (10) = 1100 lumens of egress illumination for 90 minutes.)

Battery options are not available in fixtures less than 4', and other limitations apply, consult factory. Entire "direct" luminaire housing is energized by battery for lengths up to 5'. 4' sections of luminaire of direct fixtures are energized by battery for 6' - 8' housing lengths. Emergency or night light circuit available (requires additional power circuit). Battery fixtures ship with an additional Orange "constant hot" Wire.

### LUMEN MAINTENANCE

90% of initial light output (L90) at 48,000+ hours, 70% of initial light output (L70) at 72,000+ hours.

### GENERATOR TRANSFER DEVICES

Generator Transfer Devices (**GTD**) emergency lighting control device senses the loss of normal power and switches the AC driver input power connection to a generator (or central inverter) supplied lighting circuit. When a Generator Transfer Device (**GTD**) is provided in a fixture it will ship with 3 additional wires (Orange Wire "constant hot", Black-Red Wire "generator hot", White-Red Wire "generator neutral").

### FIXTURE FINISH

Standard finishes are powder coat painted White Painted Finish (**WH**), Silver Painted Finish (**SV**) or Black Painted Finish (**BK**). Consult factory for Custom Color Painted Finish (**CC**).

### INSTALLATION AND MOUNTING

LPZERO mounts to acoustical grid ceilings (**T1/T9/TS**) and Inaccessible Ceilings or Grid Ceilings (**GP**). LPZERO can utilize Square Rotating End Caps (**SEC**) which allows for adjustment of luminaires directional distribution with 359° of rotational tilt between mounting points. Luminaire power supplies are remote mounted above the ceiling or onto the ceiling surface. The maximum distance between a luminaire and remote driver enclosure is 25'. Each luminaire requires a dedicated remote power supply.

LPZERO is suspended using an adjustable Standard Aircraft Cable and a preattached Power Cord Suspension (**PC**) up to 240" from ceiling surface. RPZERO can also be suspended from Rigid Stem Suspension (**RS**) mounting points up to 12" from ceiling surface. Aircraft cables are 1mm stainless steel with nickel plated gripper at canopy. Rigid stems are 3/8" diameter steel tube finished with matte paint.

LPZERO can be individually mounted or continuously mounted in linear configurations or complex patterns. Refer to data sheets and installation instructions for details on fixture dimensions, mounting location dimensions and available luminaire configurations.

### WARRANTY

5-year limited warranty on LED and driver from date of shipment. Refer to the full warranty details on [nulite.lighting](http://nulite.lighting).

### WEIGHT

Pendant mounted luminaire weight is 0.5 lbs/ft, Remote power supply weights vary per remote driver enclosure type and electrical configuration, consult factory.

### APPROVALS

ETL listed, conforms to UL standard 1598 / 8750 and CSA standard C22.2, indoor dry/damp locations.

### TESTING AND CERTIFICATION

All of Nulite's LED components have been tested under LM-80 guidelines insuring 6000 hours of luminous flux data. Additionally Nulite can supply LM-79 data on all luminaires. This data includes luminous flux, electrical power, efficiency, chromatically as well as the diffusion of luminous intensity.