

Regolo 4

RM4-D

Recessed/Mud
DIRECT
 Light Distribution



The Regolo RM4 LED series is a recessed, nominal 4" wide profile, slot unit designed to be mud in for a trimless appearance. The product is ideal for illuminating corridors, open and private offices, classrooms, lobbies and general purpose rooms.

- **Extruded aluminum side rails and heavy gauge end caps.**
- **Configure into linear rows, complex patterns and individual geometric shapes**
- **Intelligent wireless technology inside from premier connected lighting partners**
- **IC Rated**

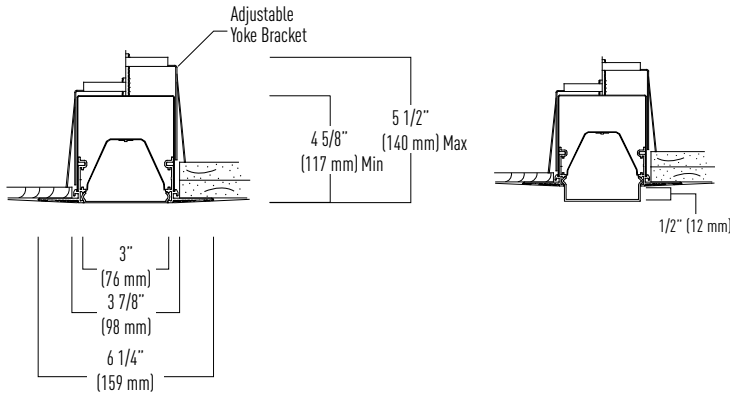

Standard Individual Fixture Lengths

2' (609 mm)	
3' (914 mm)	
4' (1219 mm)	
5' (1524 mm)	
6' (1828 mm)	
7' (2133 mm)	
8' (2438 mm)	

RM4 / Frosted Flush Lens

ORDERING INFORMATION / Example: RM4-D-FRF-09-L35-UNV-D-11-WH

SERIES	DISTRIBUTION	DIRECT SHIELDING	LUMENS DOWN	CRI & CCT	
RM4 - Recessed Linear LED Luminaire Designed for Sheet Rock Ceilings, Nominal 4" Aperture Width.	D - Direct	ST - Satin White FR - Frosted (High Efficiency)	F - Flush Lens R - Regressed Lens D - Drop Lens (Opaque Ends) L - Drop Lens (Luminous Ends) BW - Batwing Lens ASYM - Asymmetric Lens	03 - 300 lm/ft 05 - 500 lm/ft 06 - 600 lm/ft 09 - 900 lm/ft 10 - 1000 lm/ft 13 - 1300 lm/ft 15 - 1500 lm/ft	L - 80 CRI H - 90 CRI 30 - 3000K 35 - 3500K 40 - 4000K

VOLTAGE	DRIVER	CIRCUITING
UNV - Universal 120 - 277V 120V - 120V 277V - 277V 347V - 347V	Dimming 0-10V D - Dim to 1% (Standard) DO - Dim to 1%, Fade to Off DO2 - Eldoled Solodrive, Dim to 0% LUTRON - See options on page 3 DALI Dimming ELE - Eldoled Ecodrive, Dim to 1% ELS - Eldoled Solodrive, Dim to 0%	Qty of Power Circuits 1 - 1 Power 2 - 2 Power 3 - 3 Power

FIXTURE FINISH	OPTIONS	FIXTURE LENGTH
WH - White Painted Finish SV - Silver Painted Finish BK - Black Painted Finish CC - Custom Painted Color Finish	LEV - Leviton Integral Sensor WS - Wattstopper (Legrand) Integral Sensor WLX - Wavelinx (Cooper Lighting Solutions) Integral Sensor NX - NX (Hubbel) Integral Sensor NLT - nLight (Acuity Brands) Integral Sensor ATH - Athena (Lutron) Integral Sensor LV - Vive (Lutron) Integral Sensor ENL - Enlighted Integral Sensor CP - Chicago Plenum GLR - Fusing	2 - 24" 3 - 36" 4 - 48" 5 - 60" 6 - 72" 7 - 84" 8 - 96" XX - Specify run lengths in 1/8" increments. Consult factory for custom lengths.

PHOTOMETRICS

*LUMEN OUTPUT MAY VARY. 3500K / 80 CRI USED FOR RESULTS.

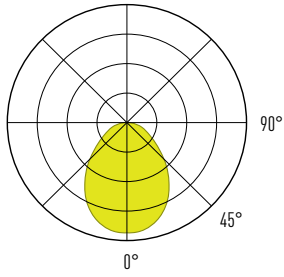

FRF - Frosted Flush Lens			
PACKAGE	Lumens per ft	Watts per ft	Lumens per watt
03	295	2.2	132
05	509	3.8	134
06	603	4.5	134
09	904	7.1	127
10	996	7.9	125
13	1312	10.6	123
15	1508	12.3	122

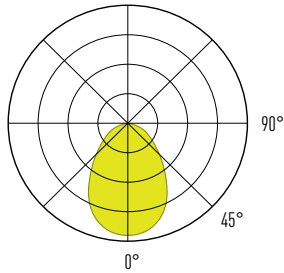

FRR - Frosted Regressed Lens			
PACKAGE	Lumens per ft	Watts per ft	Lumens per watt
03	288	2.2	129
05	497	3.8	131
06	589	4.5	131
09	906	7.3	124
10	996	8.2	122
13	1304	10.8	120
15	1499	12.5	119

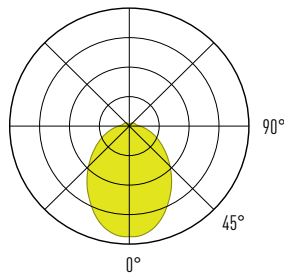

FRL - Frosted Drop Lens (Luminous Ends)			
PACKAGE	Lumens per ft	Watts per ft	Lumens per watt
03	299	2.2	133
05	491	3.7	134
06	611	4.5	135
09	893	6.9	130
10	1009	7.9	127
13	1306	10.5	125
15	1508	12.2	124

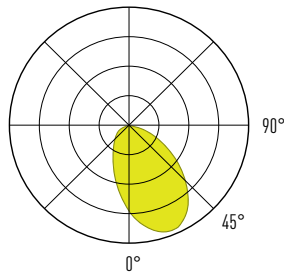

ASYM - Asymmetric Lens			
PACKAGE	Lumens per ft	Watts per ft	Lumens per watt
03	307	2.2	137
05	505	3.7	138
06	603	4.3	139
09	894	6.7	134
10	989	7.7	129
13	1296	10.1	128
15	1504	11.8	128

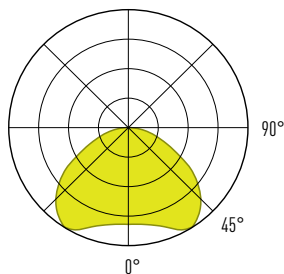

BW - Batwing Lens			
PACKAGE	Lumens per ft	Watts per ft	Lumens per watt
03	305	2.4	126
05	510	4.0	128
06	599	4.7	127
09	910	7.7	118
10	997	8.4	119
13	1298	11.0	118
15	1510	12.9	117

DRIVER INFORMATION

NULITE CAT#	DRIVER MANUFACTURER / SERIES	DIMMING / CONTROL PROTOCOL	DIM RANGE	NOTES/ DESCRIPTION
D	Signify Xitanium, Osram OTI	0-10v	100% - 1%	Standard Nulite driver, base fixture price
D0	Signify Xitanium, Osram OTI	0-10v	100%- 1% (Steps from 1% to 0% or OFF)	Standard Nulite driver, base fixture price
D02	Eldoled Solodrive	0-10v	100% - 0%	Logarithmic Dimming Curve
L11	Lutron Hi-Lume Premier (PEQOE) Max lumen package 03	0-10v	100% - 0.1%	Hi-Lume Premier 0.1% EcoSystem LED driver with Soft-on, Fade-to-Black dimming technology
L15	Lutron Hi-Lume Series (LDE1)	0-10v	100% - 1%	Hi-Lume 1% EcoSystem LED driver with Soft-on, Fade-to-Black dimming technology
ELE	Eldoled Ecodrive	DALI	100% - 1%	Logarithmic Dimming Curve
ELS	Eldoled Solodrive	DALI	100% - 0%	Logarithmic Dimming Curve

LENS OPTIONS



Frosted Lens (High Efficiency) (FR)

This diffuser is designed for a balance between efficiency and lens uniformity. (Transmission ~ 89%)

Satin White Lens (ST)

This diffuser is designed for visible lens uniformity. It's recommended for regressed lens configuration in our shallow housing. (Transmission ~ 69%)



Flush Lens (FF)



Regressed Lens (R)



Drop Lens (Luminous Ends) (L)

DSOS SENSOR OPTION

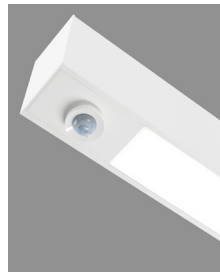

Integral Daylight and Occupancy Sensor

The Regolo series is available with a combination PIR occupancy and daylight sensor for daylight harvesting. Consult factory for more details on sensor operation and commissioning.

PRODUCT SPECIFICATIONS AND INFORMATION

HOUSING CONSTRUCTION

The housing consists of visible extruded aluminum flange rails with formed cold rolled steel back channel and heavy gauge end caps. Steel alignment tabs and white snap-in joiner clips are used for continuous row applications. Standard luminaire is finished textured white.

LEDS AND OPTICAL SYSTEM

Optical systems consist of a single row of mid power constant current LEDs mounted to a removable highly reflective powder coated metal reflector. Frosted lens diffuses LED light source while delivering high efficacy general illumination.

STANDARD DIMMING LED DRIVERS

Standard constant current integral electronic 0-10v dimming input. Two standard driver options are available. Option **D** dims to 1% and option **DO** dims to 0% or OFF (the final 1 percent is a "step"). Both options are the same price and representative of the base fixture price. Options **D** and **DO** ship with 5 wires (Line Voltage- Black and White wires, Low Voltage- Purple and Pink wires, Ground- Green wire).

DALI DRIVERS

Standard constant current DALI drivers available in either a dim to 1% (**ELE**) or dim to 0% (**ELS**). DALI fixtures ship with 5 wires (Line Voltage- Black and White wires, Low Voltage- Purple and Pink wires, Ground- Green wire).

LIGHT OUTPUT

Standard factory set light outputs are programmed to within +/- 5% of the nominal light level at 3500K 80 CRI LEDs. Light output, wattage, and efficacy will vary across different CRI's CCT's. Refer to ies files on the website for actual detailed lighting performance data.

CIRCUITING

Each luminaire may have up to 3 line voltage (Power) circuits and 6 low voltage (Control) circuits. Two power circuits are required for independent control of uplight and downlight in bi-direct luminaires, and low voltage control circuits are for independent dimming of each circuit.

Examples:

- **"1-1"**- 1 power circuit (Line Voltage) and 1 control circuit (Low Voltage) > 5 wires total (1 Black Wire "Hot", 1 White Wire "Neutral", 1 Green Wire "Ground", and 2 low voltage control wires, 1 Pink wire and 1 Purple wire)
- **"2-2"**- 2 power circuits (Line Voltage) and 2 control circuit (Low Voltage) > 9 wires total (2 Black Wires "Hot", 2 White Wires "Neutral", 1 Green Wire "Ground", and 4 low voltage control wires, 2 Pink wires and 2 Purple wires)
- **"3-3"**- 3 power circuits (Line Voltage) and 3 control circuit (Low Voltage) > 13 wires total (3 Black Wires "Hot", 3 White Wires "Neutral", 1 Green Wire "Ground", and 6 low voltage control wires, 2 Pink wires and 2 Purple wires)

BATTERY PACKS

Recyclable Ni-Cad battery pack, battery run time is 90 minutes. Recharge time of 24 hours. Battery packs up to 15W are available. To calculate Battery Lumen Output, multiply luminaire efficacy by battery wattage. (example: 120 lms/watt (**120**) x **B10** Battery Wattage (**10**) = **1200** lumens of egress illumination for 90 minutes.) Battery option not available in fixtures less than 4', and other limitations apply, consult factory. Entire "direct" fixture housing is energized by battery for lengths up to 5'. Half of direct fixture is energized by battery for 6' - 8' housing lengths. Emergency or night light circuit available (requires additional power circuit). Battery fixtures ship with an additional Orange "constant hot" wire.

LUMEN MAINTENANCE

90% of initial light output (L90) at 100,000+ hours, 70% of initial light output (L70) at 200,000+ hours.

GENERATOR TRANSFER DEVICES

The GTD emergency lighting control device senses the loss of normal power and switches the AC driver input power connection to an unswitched, generator (or central inverter) supplied lighting circuit. GTD fixtures ship with 3 additional wires (Orange wire "constant hot", Black-Red wire "generator hot", White-Red wire "generator neutral").

FIXTURE FINISHES

Standard finishes are powder coat painted White Painted Finish (**WH**), Silver Painted Finish (**SV**) or Black Painted Finish (**BK**). Consult factory for Custom Color Painted Finish (**CC**).

INSTALLATION AND MOUNTING

The "Mud Trim" recessed option is designed to install into sheet rock ceilings where plaster is required to be applied to the mounting flange and then sanded smooth to create the perception of a flangeless installation. Refer to installation instructions at <https://nulite.lighting/> for detailed installation instructions.

WARRANTY

5-year limited warranty on LED and driver from date of shipment. Refer to the full warranty details on www.nulite-lighting.com/products/184.

WEIGHT

Fixtures are 3.25 lbs/ft. Driver box weights vary per enclosure type and electrical configuration, consult factory.

APPROVALS

ETL listed, conforms to UL Standard 1598 and CSA Standard C22.2, indoor dry/damp locations.

TESTING AND CERTIFICATION

All of Nulite's LED components have been tested under **LM-80** guidelines insuring 6000 hours of luminous flux data. Additionally Nulite can supply **LM-79** data on all luminaires. This data includes luminous flux, electrical power, efficiency, chromaticity as well as the diffusion of luminous intensity.