

Regolo 2

RR2-D

Surface Mount

DIRECT
Light Distribution



The Regolo RR2 series is a narrow, nominal 2" wide, surface mount LED luminaire. The slender design is ideal for corridors, open and private offices, classrooms, lobbies and general purpose rooms.

- **Extruded aluminum side rails and heavy gauge end caps.**
- **Configure into linear rows, complex patterns and individual geometric shapes**
- **Intelligent wireless technology inside from premier connected lighting partners**
- **Available in 3 standard paint finishes**

Quick Ship: 10 Day lead time for options highlighted in orange. Available in 4' nominal increments; includes 4' & 8' standalone fixtures and continuous rows. Limited to 1000 ft per order.

Standard Individual Fixture Lengths

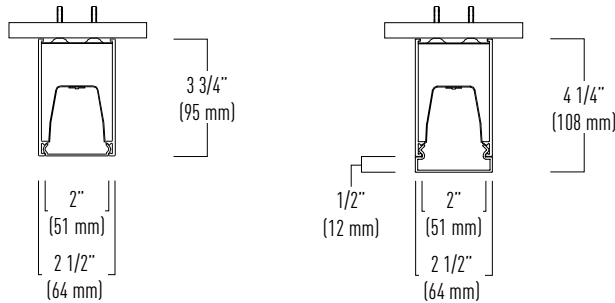
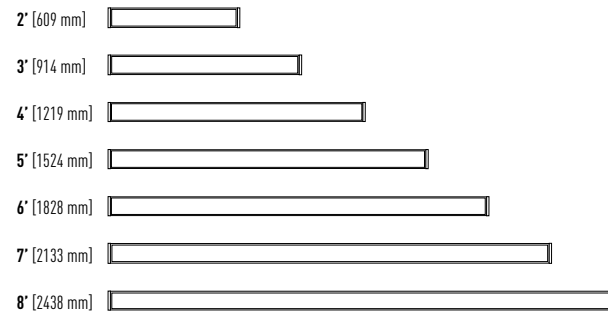

RR24-D / Frosted Flush Lens

RR24-D / Frosted Drop Lens

ORDERING INFORMATION / Example: RR2-D-FRF-09-L40-UNV-D-11-WH-4

SERIES	DISTRIBUTION	DIRECT SHIELDING	LUMENS DOWN	CRI & CCT	
RR2 - Surface Mounted Linear LED Luminaire, Nominal 2" Aperture Width	D - Direct	ST - Satin White FR - Frosted (High Efficiency)	F - Flush Lens FCL - Flush Continuous Lens D - Drop Lens (Opaque Ends) L - Drop Lens (Luminous Ends) BW - Batwing Lens ASYM - Asymmetric Lens	03 - 300 lm/ft 05 - 500 lm/ft 06 - 600 lm/ft 09 - 900 lm/ft 10 - 1000 lm/ft	L - 80 CRI H - 90 CRI 30 - 3000K 35 - 3500K 40 - 4000K

VOLTAGE	DRIVERS & CONTROLS	CIRCUITING
UNV - Universal 120 - 277V 120V - 120V 277V - 277V 347V - 347V	Dimming 0-10V D - Dim to 1% (Standard) DO - Dim to 1%, Fade to Off LUTRON - See options on page 3 DALI DAO - Dim to 1%, Dim to Off	Qty of Power Circuits 1 - 1 Power 2 - 2 Power 3 - 3 Power
	*Sensor & Control (Options On Page 4) SSW - Acuity Sensor Switch NLT - Acuity nLight** WLX - Cooper Wavelinx** ATH - Lutron Athena LV - Lutron Vibe WS - Wattstopper LEV - Leviton Intellect** NX - Current NX Lighting and Controls AVI - Avion	Qty of Control Circuits 1 - 1 Control 2 - 2 Control 3 - 3 Control
	*Contact Factory for multi circuit configurations. **Emergency circuit option available.	Options B10 - 10 Watt Battery Pack (CEC Compliant) B14 - 14 Watt Battery Pack (CEC Compliant) B15 - 15 Watt Battery Pack (CEC Compliant) GTD - Generator Transfer Device (120V or 277V) EM - Dedicated Emergency Circuit

FIXTURE FINISH	OPTIONS	FIXTURE LENGTH
WH - White Painted Finish SV - Silver Painted Finish BK - Black Painted Finish CC - Custom Painted Color Finish	CP - Chicago Plenum GLR - Fusing	2 - 24" 3 - 36" 4 - 48" 5 - 60" 6 - 72" 7 - 84" 8 - 96" XX - Specify run lengths in 1/8" increments (QS 4' increments). Consult factory for custom lengths.

PHOTOMETRICS

*LUMEN OUTPUT MAY VARY. 3500K / 80 CRI USED FOR RESULTS.

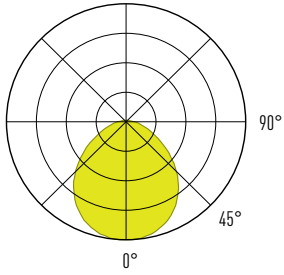

FRF - Frosted Flush Lens			
PACKAGE	Lumens per ft	Watts per ft	Lumens per watt
03	297	2.4	123
05	495	4.0	124
06	604	4.9	123
09	905	7.7	117
10	999	8.6	116

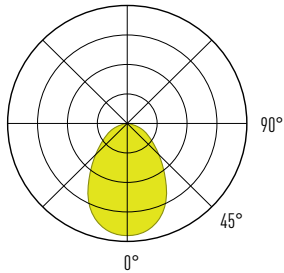

FRL - Frosted Drop Lens			
PACKAGE	Lumens per ft	Watts per ft	Lumens per watt
03	295	2.9	122
05	492	4.0	124
06	600	4.9	123
09	898	7.7	116
10	1004	8.8	114

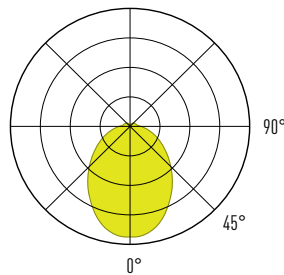

FRR - Frosted Regressed Lens			
PACKAGE	Lumens per ft	Watts per ft	Lumens per watt
03	309	2.9	105
05	495	4.7	105
06	604	5.9	103
09	895	9.2	97
10	1001	10.3	97

DRIVER INFORMATION

NULITE CAT#	DRIVER MANUFACTURER / SERIES	DIMMING / CONTROL PROTOCOL	DIM RANGE	NOTES/ DESCRIPTION
D	Signify Xitanium, Osram OTI or Similar	0-10v	100% -1%	Standard Nulite driver, base fixture price
D0	Signify Xitanium, Osram OTI or Similar	0-10v	100%- 1% (Steps from 1% to 0% or OFF)	Standard Nulite driver, base fixture price
L11	Lutron Hi-Lume Premier (PEQ0E) Max lumen package 03	0-10v	100% - 0.1%	Hi-Lume Premier 0.1% EcoSystem LED driver with Soft-on, Fade-to-Black dimming technology
L15	Lutron Hi-Lume Series (LDE1)	0-10v	100% - 1%	Hi-Lume 1% EcoSystem LED driver with Soft-on, Fade-to-Black dimming technology
DA0	Eldoled or Similar	DALI	100%- 1% (Steps from 1% to 0% or OFF)	DALI with Dim to Off

LENS OPTIONS



Frosted Lens (High Efficiency) (FR)
This diffuser is designed for a balance between efficiency and lens uniformity. (Transmission ~ 89%)

Satin White Lens (ST)
This diffuser is designed for visible lens uniformity. It's recommended for regressed lens configuration in our shallow housing. (Transmission ~ 69%)

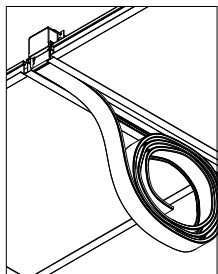
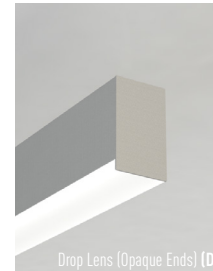
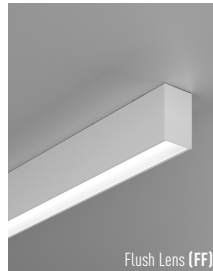

Flush Continuous Lens (FCL)
The Regolo series is available with a Flush Continuous Lens (FCL) option that eliminates lens gaps and provides seamless uniform illumination for linear lengths up to 40'.

SENSOR OPTIONS

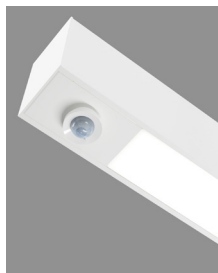

Integral Daylight and Occupancy Sensor
The Regolo series is available with a combination PIR occupancy and daylight sensor for daylight harvesting.

For more details on compatible sensor and control options review Nulite's sensor comparability chart on pages 4-6. Consult factory for more details on sensor operation and commissioning.



SENSOR & CONTROL COMPATIBILITY AND SPECIFICATION



OEM Connected Lighting Partners

Nulite has formed strategic partnerships with premier OEM suppliers of smart lighting control platforms. Nulite's focus is primarily on embedded fixture level smart sensors and power supplies ensuring system operability and code compliance.

- Fixtures are verified and tested prior to shipment
- Specification follows manufacturer required nomenclature



Ordering Example: Nulite Catalog #: **RP44-B-FRF-BW-09-09-L35-UNV-D0-SSW1-11-WH-T1W048-4**. This catalog designation merely identifies luminaires that require SSW compatible integral fixture sensors. Additional hardware such as power packs and wiring harnesses are often required to operate sensors and offer compatibility to the overall control system. Nulite will coordinate with Acuity these items and build into the price accordingly.

NULITE CATALOG NUMBER	SENSOR & CONTROL DESCRIPTION	MANUFACTURER REQUIRED NOMENCLATURE	SENSOR FUNCTIONS				SENSOR & CONTROL PART NUMBER
			WIRELESS	OCCUPANCY	PHOTOCELL	IP RATED	
SSW_							
SSW1	Integral Wireless Daylight Sensor - 0-10V or DALI	MSD-ADC / MSD-EZ-ADC					MSD-ADC or MSD-EZ-ADC
SSW2	Integral Wireless Daylight & Occupancy Sensor with Passive Infrared - 0-10V or DALI	MSD-7-ADC / MSD-7-EZ-ADC					MSD-7-ADC or MSD-7-EZ-ADC



Ordering Example: Nulite Catalog #: **RP44-B-FRF-BW-09-09-L35-UNV-D0-NLT1-11-WH-T1W048-4**. This catalog designation merely identifies luminaires that require NLT compatible integral fixture sensors. Additional hardware such as power packs and wiring harnesses are often required to operate sensors and offer compatibility to the overall control system. Nulite will coordinate with Acuity Brands on these items and build into the price accordingly.

NULITE CATALOG NUMBER	SENSOR & CONTROL DESCRIPTION	MANUFACTURER REQUIRED NOMENCLATURE	SENSOR FUNCTIONS				SENSOR & CONTROL PART NUMBER
			WIRELESS	OCCUPANCY	PHOTOCELL	IP RATED	
NLT_							
NLT1	Integral Wireless Control Module - 0-10V or DALI	NLTAIR2 / NLTAIREM2					RIO EZDL or RIO ZTS RIO EZDL EM or RIO ZT EM (For EM Only)
*NLT2	Integral Wireless Occupancy Sensor with Passive Infrared - 0-10V or DALI	NLTAIR2 PIR / NLTAIREM2 PIR					RES7 or RES7 ZTS RES7 EM or RES7 ZT EM (For EM Only)
NLT3	Integral Wireless Occupancy Sensor with Passive Infrared and Photocell - 0-10V or DALI	NLTAIR2 APIR / NLTAIREM2 APIR					RES7 or RES7 ZTS RES7 EM or RES7 ZT EM (For EM Only)
NLT4	Integral Wired Control Module - 0-10V or DALI	NLIGHT / NLIGHT ER					nIO EZ PH or nIO EZDXA nIO EZ PH ER or nIO EZDCL ER (For EM Only)
*NLT5	Integral Wired Control Module and Occupancy Sensor with Passive Infrared - 0-10V or DALI	NLIGHT PIR / NLIGHTER PIR					nIO EZ PH or nIO EZDXA with nES7 nIO EZ PH ER or nIO EZDCL ER with nES7 (For EM Only)
NLT6	Integral Wired Control Module and Occupancy Sensor with Passive Infrared and Photocell - 0-10V or DALI	NLIGHT APIR / NLIGHT ER APIR					nIO EZ PH or nIO EZDXA with nES7 nIO EZ PH ER or nIO EZDCL ER with nES7 (For EM Only)

*Contact Factory for unlisted configuration options.

*During commissioning, the commissioning agent must disable the photosensing capability to only have occupancy sensing.



Ordering Example: Nulite Catalog #: **RP44-B-FRF-BW-09-09-L35-UNV-D0-WLX1-11-WH-T1W048-4**. This catalog designation merely identifies luminaires that require WLX compatible integral fixture sensors. Additional hardware such as power packs and wiring harnesses are often required to operate sensors and offer compatibility to the overall control system. Nulite will coordinate with Cooper Lighting Solutions on these items and build into the price accordingly.

NULITE CATALOG NUMBER	SENSOR & CONTROL DESCRIPTION	MANUFACTURER REQUIRED NOMENCLATURE	SENSOR FUNCTIONS				SENSOR & CONTROL PART NUMBER
			WIRELESS	OCCUPANCY	PHOTOCELL	IP RATED	
WLX_							
WLX1	Integral Wireless Pro Direct Connect Occupancy Sensor with Photocell - 0-10V	OEM-WAA-D					OEM-WAA-D
WLX2	Integral Wireless Pro Direct Connect Occupancy Sensor with Photocell - 0-10V	OEM-WAA					OEM-WAA (Available for EM and standard configurations)
WLX3	Integral Wireless Control Node - 0-10V	OEM-WPN					OEM-WPN



Ordering Example: Nulite Catalog #: **RP44-B-FRF-BW-09-09-L35-UNV-D0-ATH1-11-WH-T1W048-4**. This catalog designation merely identifies luminaires that require ATH compatible integral fixture sensors. Additional hardware such as power packs and wiring harnesses are often required to operate sensors and offer compatibility to the overall control system. Nulite will coordinate with Lutron these items and build into the price accordingly.

NULITE CATALOG NUMBER	SENSOR & CONTROL DESCRIPTION	MANUFACTURER REQUIRED NOMENCLATURE	SENSOR FUNCTIONS				SENSOR & CONTROL PART NUMBER
			WIRELESS	OCCUPANCY	PHOTOCELL	IP RATED	
ATH_							
ATH1	Integral Wireless Node with PIR Sensor with Photocell. White or Black finish - 0-10V or DALI	A-WN-D01-OCC					A-WN-D01-OCC
ATH2	Integral Wireless Node. Radio Frequency (RF) detection only. White or Black Finish - 0-10V or DALI	A-WN-D01-RF					A-WN-D01-RF

- Also available in EM configurations
- Nulite is not responsible for UL924 devices in Lutron Athena enabled EM fixtures
- Contractor is responsible for providing LUT-SHUNT-A-TD-5 and QP5-2L-POE-EM or Q-POE-PNL-EM for UL924 configurations



Ordering Example: Nulite Catalog #: **RP44-B-FRF-BW-09-09-L35-UNV-D0-LV1-11-WH-T1W048-4**. This catalog designation merely identifies luminaires that require LV compatible integral fixture sensors. Additional hardware such as power packs and wiring harnesses are often required to operate sensors and offer compatibility to the overall control system. Nulite will coordinate with Lutron these items and build into the price accordingly.

NULITE CATALOG NUMBER	SENSOR & CONTROL DESCRIPTION	MANUFACTURER REQUIRED NOMENCLATURE	SENSOR FUNCTIONS				SENSOR & CONTROL PART NUMBER
			WIRELESS	OCCUPANCY	PHOTOCELL	IP RATED	
LV_							
LV1	Integral Wireless VIVE Sensor with PIR and Photocell - DALI	DFCSJ-OEM-OCC					DFCSJ-OEM-OCC
LV2	Integral wireless node. Radio Frequency (RF) Detection Only. White or Black Finish - 0-10V or DALI	DFCSJ-OEM-RF					DFCSJ-OEM-RF



Ordering Example: Nulite Catalog #: **RP44-B-FRF-BW-09-09-L35-UNV-D0-WS1-11-WH-T1W048-4**. This catalog designation merely identifies luminaires that require WS compatible integral fixture sensors. Additional hardware such as power packs and wiring harnesses are often required to operate sensors and offer compatibility to the overall control system. Nulite will coordinate with Legrand these items and build into the price accordingly.

NULITE CATALOG NUMBER	SENSOR & CONTROL DESCRIPTION	MANUFACTURER REQUIRED NOMENCLATURE	SENSOR FUNCTIONS				SENSOR & CONTROL PART NUMBER
			WIRELESS	OCCUPANCY	PHOTOCELL	IP RATED	
WS_							
WS1	Integral Wireless PIR Sensor with Photocell - 0-10V or DALI	LMFS-601-W					LMFS-601-W (DALI) LMFS-601-W with LMFI-111 (0-10v)



Ordering Example: Nulite Catalog #: **RP44-B-FRF-BW-09-09-L35-UNV-D0-LEV1-11-WH-T1W048-4**. This catalog designation merely identifies luminaires that require LEV compatible integral fixture sensors. Additional hardware such as power packs and wiring harnesses are often required to operate sensors and offer compatibility to the overall control system. Nulite will coordinate with Leviton these items and build into the price accordingly.

NULITE CATALOG NUMBER	SENSOR & CONTROL DESCRIPTION	MANUFACTURER REQUIRED NOMENCLATURE	SENSOR FUNCTIONS				SENSOR & CONTROL PART NUMBER
			WIRELESS	OCCUPANCY	PHOTOCELL	IP RATED	
LEV_							
LEV1	Integral Wireless Intellect Controlled PIR Sensor with Photocell - 0-10V or DALI	ZL07S-N00 / ZL0DS-N00					ZL07S-N00 or ZL0DS-N00
LEV2	Integral Wireless Intellect Fixture node. No sensor - 0-10V or DALI	ZL070-N00 / ZL0D0-N00					ZL070-N00 or ZL0D0-N00
LEV3	Integral Wireless Intellect Single Channel Fixture Controller. No sensor - 0-10V or DALI	ZL070-B00 / ZL0D0-B00					ZL070-B00 or ZL0D0-B00
LEV4	Integral Wireless Intellect 0-10V 2-Channel Fixture Controller. No sensor	ZL070-B20					ZL070-B20



Ordering Example: Nulite Catalog #: **RP44-B-FRF-BW-09-09-L35-UNV-D0-NX1-11-WH-T1W048-4**. This catalog designation merely identifies luminaires that require NX Lighting and Controls compatible integral fixture sensors. Additional hardware such as power packs and wiring harnesses are often required to operate sensors and offer compatibility to the overall control system. Nulite will coordinate with Current these items and build into the price accordingly.

NULITE CATALOG NUMBER	SENSOR & CONTROL DESCRIPTION	MANUFACTURER REQUIRED NOMENCLATURE	SENSOR FUNCTIONS				SENSOR & CONTROL PART NUMBER
			WIRELESS	OCCUPANCY	PHOTOCELL	IP RATED	
NX_							
NX1	Integral PIR and Photocell Sensor. Low Mount Indoor - 0-10V	NXSMP-LMI					NXSMP-LMI with NXFM2-1R2D-I-UNV



Ordering Example: Nulite Catalog #: **RP44-B-FRF-BW-09-09-L35-UNV-D0-AV11-11-WH-T1W048-4**. This catalog designation merely identifies luminaires that require AVI compatible integral fixture sensors. Additional hardware such as power packs and wiring harnesses are often required to operate sensors and offer compatibility to the overall control system. Nulite will coordinate with Avi-Labs these items and build into the price accordingly.

NULITE CATALOG NUMBER	SENSOR & CONTROL DESCRIPTION	MANUFACTURER REQUIRED NOMENCLATURE	SENSOR FUNCTIONS				SENSOR & CONTROL PART NUMBER
			WIRELESS	OCCUPANCY	PHOTOCELL	IP RATED	
AVI_							
AV11	Integral Direct Connect Microwave Occupancy and Photocell Sensor - 0-10V	AVI-DC-MW					AVI-DC-MW with AVI-B-LVFA-12-24VDC-1CH

PRODUCT SPECIFICATIONS AND INFORMATION

HOUSING CONSTRUCTION

The housing consists of visible extruded aluminum flange rails with formed cold rolled steel back channel and heavy gauge end caps. Steel alignment tabs and white snap-in joiner clips are used for continuous row applications. Standard luminaire is finished textured white.

LEDS AND OPTICAL SYSTEM

Optical systems consist of a single row of mid power constant current LEDs mounted to a removable highly reflective powder coated metal reflector. Frosted lens diffuses LED light source while delivering high efficacy general illumination.

STANDARD DIMMING LED DRIVERS

Standard constant current integral electronic 0-10v dimming input. Two standard driver options are available. Option **D** dims to 1% and option **DO** dims to 0% or OFF (the final 1 percent is a "step"). Both options are the same price and representative of the base fixture price. Options **D** and **DO** ship with 5 wires (Line Voltage- Black and White wires, Low Voltage- Purple and Pink wires, Ground- Green wire).

DALI DRIVERS

Standard constant current DALI drivers available in **DAO** dim to 0% or OFF (the final 1 percent is a "step"). DALI fixtures ship with 5 wires (Line Voltage- Black and White wires, Low Voltage- Purple and Pink wires, Ground- Green wire).

LIGHT OUTPUT

Standard factory set light outputs are programmed to within +/- 5% of the nominal light level at 3500K 80 CRI LEDs. Light output, wattage, and efficacy will vary across different CRI's CCT's. Refer to ies files on the website for actual detailed lighting performance data.

CIRCUITING

Each luminaire may have up to 3 line voltage (Power) circuits and 6 low voltage (Control) circuits. Two power circuits are required for independent control of uplight and downlight in bi-direct luminaires, and low voltage control circuits are for independent dimming of each circuit.

Examples:

- **"1-1"**- 1 power circuit (Line Voltage) and 1 control circuit (Low Voltage) > 5 wires total (1 Black Wire "Hot", 1 White Wire "Neutral", 1 Green Wire "Ground", and 2 low voltage control wires, 1 Pink wire and 1 Purple wire)
- **"2-2"**- 2 power circuits (Line Voltage) and 2 control circuit (Low Voltage) > 9 wires total (2 Black Wires "Hot", 2 White Wires "Neutral", 1 Green Wire "Ground", and 4 low voltage control wires, 2 Pink wires and 2 Purple wires)
- **"3-3"**- 3 power circuits (Line Voltage) and 3 control circuit (Low Voltage) > 13 wires total (3 Black Wires "Hot", 3 White Wires "Neutral", 1 Green Wire "Ground", and 6 low voltage control wires, 2 Pink wires and 2 Purple wires)

BATTERY PACKS

Recyclable Ni-Cad battery pack, battery run time is 90 minutes. Recharge time of 24 hours. Battery packs up to 15W are available. To calculate Battery Lumen Output, multiply luminaire efficacy by battery wattage. (example: 120 lms/watt (**120**) x **B10** Battery Wattage (**10**) = **1200** lumens of egress illumination for 90 minutes.) Battery option not available in fixtures less than 4', and other limitations apply, consult factory. Entire "direct" fixture housing is energized by battery for lengths up to 5'. Half of direct fixture is energized by battery for 6' - 8' housing lengths. Emergency or night light circuit available (requires additional power circuit). Battery fixtures ship with an additional Orange "constant hot" wire.

LUMEN MAINTENANCE

90% of initial light output (L90) at 100,000+ hours, 70% of initial light output (L70) at 200,000+ hours.

GENERATOR TRANSFER DEVICES

The GTD emergency lighting control device senses the loss of normal power and switches the AC driver input power connection to an unswitched, generator (or central inverter) supplied lighting circuit. GTD fixtures ship with 3 additional wires (Orange wire "constant hot", Black-Red wire "generator hot", White-Red wire "generator neutral").

FIXTURE FINISHES

Standard finishes are powder coat painted White Painted Finish (**WH**), Silver Painted Finish (**SV**) or Black Painted Finish (**BK**). Consult factory for Custom Color Painted Finish (**CC**).

INSTALLATION AND MOUNTING

RR2 is designed to be surface mounted to an architectural building surface. The fixture must be secured to structure at specific locations along the fixture length and power must be also be roughed in at specific locations prior to installation. RR2 may be individually mounted or continuously mounted in linear configurations or complex geometric patterns. Refer to installation instructions at nulite.lighting.

WARRANTY

5-year limited warranty on LED and driver from date of shipment. Refer to the full warranty details on nulite.lighting.

WEIGHT

Fixtures are 3.25 lbs/ft. Driver box weights vary per enclosure type and electrical configuration, consult factory.

APPROVALS

ETL listed, conforms to UL Standard 1598 and CSA Standard C22.2, indoor dry/damp locations.

TESTING AND CERTIFICATION

All of Nulite's LED components have been tested under **LM-80** guidelines insuring 6000 hours of luminous flux data. Additionally Nulite can supply **LM-79** data on all luminaires. This data includes luminous flux, electrical power, efficiency, chromatically as well as the diffusion of luminous intensity.