

RPZERO-TRI(L48) (MJ)

# Regolo Zero RZERO SHAPES

Pendant/Surface

**DIRECTIONAL**  
Light Distribution



The Regolo Zero directional pendant and surface mount creates ideal lighting conditions for a multitude of spaces. Offered in a sub 1-inch aperture utilizing a directional light distribution and various mounting options.

- **Sub 1" aperture extruded acrylic lens**
- **Available in 3 standard paint finishes and custom colors**
- **Tool free installation with the engineered NuLoc™ joining system**
- **Connect fixtures using mitered, pivot and curved joints**
- **Configure into linear rows, complex patterns and individual geometric shapes**

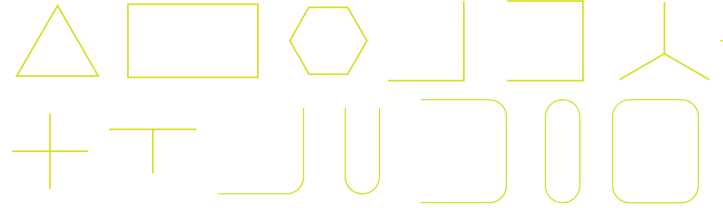

**ORDERING INFORMATION** / Example: RPZERO-D-FF-L40-FEC-UNV-D-11-WH-MJ-T1WPC048-TRI(L48x48x48)

SERIES	DISTRIBUTION	SHIELDING	LUMEN PACKAGE	CRI/ CCT	END CAP	VOLTAGE	DRIVER (REMOTE)
<b>RPZERO</b> - Regolo Zero 1" Wide, 1" Tall, Directional Remote Pendant Mount	<b>D</b> - Directional	<b>FF</b> - Frosted Flush Lens <b>BF</b> - Black Flush Lens	<b>03</b> - 300 lm/ft <b>04</b> - 400 lm/ft <b>05</b> - 500 lm/ft <b>08</b> - 800 lm/ft	<b>L30</b> - 80 CRI, 3000K <b>L35</b> - 80 CRI, 3500K <b>L40</b> - 80 CRI, 4000K <b>H30</b> - 90 CRI, 3000K <b>H35</b> - 90 CRI, 3500K <b>H40</b> - 90 CRI, 4000K	<b>FEC</b> - Flat End Cap <b>REC</b> - Round End Cap <b>SEC</b> - Square Rotating End Cap <b>NEC</b> - No End Cap	<b>UNV</b> - Universal 120 - 277V <b>120V</b> - 120V <b>277V</b> - 277V	<b>Dimming 0-10V</b> <b>D</b> - Dim to 1% (Standard) <b>D0</b> - Dim to 1%, Fade to Off <b>D02</b> - Eldoled Solodrive, Dim to 0% <b>LUTRON</b> - See options on page 2 <b>DALI Dimming</b> <b>ELE</b> - Eldoled Ecodrive, Dim to 1% <b>ELS</b> - Eldoled Solodrive, Dim to 0%
<b>RRZERO</b> - Regolo Zero 1" Wide, 1" Tall, Direct Remote Surface Mount							

\*Fixture specified with Black Flush Lens (BF) are only available in 03 and 04 lumen packages.

\*Closed shapes must be specified with No End Cap (NEC).

CIRCUITING	FIXTURE FINISH	INTERSECTION TYPE
<p><b>Qty of Power Circuits</b> 1 - 1 Power</p> <p><b>Qty of Control Circuits</b> 1 - 1 Control</p> <p><b>Emergency Options (Remote)</b>  <b>B10</b> - 10 Watt Battery Pack (CEC Compliant)  <b>B14</b> - 14 Watt Battery Pack (CEC Compliant)  <b>B15</b> - 15 Watt Battery Pack (CEC Compliant)  <b>GTD</b> - Generator Transfer Device (120V or 277V)  <b>EM</b> - Dedicated Emergency Circuit</p>	<p><b>WH</b> - White Painted Finish  <b>SV</b> - Silver Painted Finish  <b>BK</b> - Black Painted Finish  <b>CC</b> - Custom Painted Color Finish</p>	<p><b>MJ</b> - Mitered Joint  <b>PJ</b> - Pivot Joint  <b>CJ</b> - Curved Joint</p> <p>*Fixture rows specified with Square Rotating End Caps (SEC) are joined together using the Pivot Joint (PJ) see details on page 4.</p>

MOUNTING
<p><b>Ceiling Type (Remote Driver Power Supply)</b>  <b>T1</b> - 1" Ceiling Grid, Aircraft Cable Suspension (Remote "Grid" Driver Enclosure)  <b>T9</b> - 9/16" Ceiling Grid, Aircraft Cable Suspension (Remote "Grid" Driver Enclosure)  <b>TS</b> - Slot Ceiling Grid, Aircraft Cable Suspension (Remote "Grid" Driver Enclosure)  <b>GP</b> - 5 5/8" Canopy Integrated Power Supply, for Inaccessible Ceilings or Grid ceilings  <b>T1R</b> - 1" Ceiling Grid, Surface Grid Mount (Remote "Grid" Driver Enclosure)  <b>T9R</b> - 9/16" Ceiling Grid, Surface Grid Mount (Remote "Grid" Driver Enclosure)  <b>TSR</b> - Slot Ceiling Grid, Surface Grid Mount (Remote "Grid" Driver Enclosure)  <b>RR</b> - Structure Mount, Surface Mount (Remote "Grid" Driver Enclosure)  <b>RRC</b> - Structure Mount, Surface Mount With Cover Plate (Remote "Grid" Driver Enclosure)</p>

Mounting Hardware Finish	Power Suspension Type	Suspension Length (Power Cord)
<p><b>W</b> - White Canopies and Cord/Stem  <b>B</b> - Black Canopies and Cord/Stem  <b>S</b> - Silver Canopies and Stem (RS Only)  <b>CC</b> - Custom Color Canopies and Stem (RS Only)</p>	<p><b>PC</b> - Power Cord Suspension  <b>RS</b> - Rigid Stem Suspension</p>	<p><b>048</b> - 48" Power Cord  <b>120</b> - 120" Power Cord  <b>240</b> - 240" Power Cord  <b>Suspension Length (Rigid Stem)</b>  <b>06</b> - 6" Rigid Stem  <b>12</b> - 12" Rigid Stem</p>

SHAPE SELECTION		
<p><b>Open Shapes</b>  <b>L</b> (L1"x L2") - L-Shape (Lengths)  <b>U</b> (L1"x L2"x L3") - U-Shape (Lengths)  <b>T</b> (L1"x L2"x L3") - T-Shape (Lengths)  <b>Y</b> (L1"x L2"x L3") - Y-Shape (Lengths)  <b>X</b> (L1"x L2"x L3"x L4") - X-Shape (Lengths)</p>	<p><b>Closed Shapes</b>  <b>TRI</b> (L1"x L2"x L3") - Triangle Shape (Lengths)  <b>RECT</b> (L1"x L2") - Rectangle Shape (Lengths)  <b>HEX</b> (L1") - Hexagon Shape (Length)</p>	<p><b>Custom Shapes</b>  <b>C</b> (Lx"x Lx") - Custom Shape (Lengths)</p>

## PHOTOMETRICS

\*LUMEN OUTPUT MAY VARY. 3500K / 80 CRI USED FOR RESULTS.

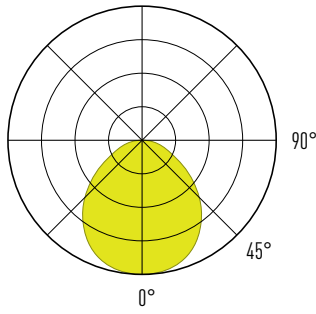

FF - Frosted Flush Lens			
PACKAGE	Lumens per ft	Watts per ft	Lumens per watt
03	293.9	3.022	97
05	506.4	5.242	97
08	808.4	8.875	91

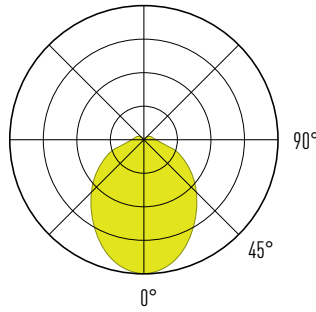

BF - Black Flush Lens			
PACKAGE	Lumens per ft	Watts per ft	Lumens per watt
03	301.8	8.190	37
04	397.6	10.974	36

## DRIVER INFORMATION

NULITE CAT#	DRIVER MANUFACTURER / SERIES	DIMMING / CONTROL PROTOCOL	DIM RANGE	NOTES/ DESCRIPTION
D	Signify Xitanium, Osram OTI	0-10v	100% -1%	Standard Nulite driver, base fixture price
D0	Signify Xitanium, Osram OTI	0-10v	100%- 1% (Steps from 1% to 0% or OFF)	Standard Nulite driver, base fixture price
D02	Eldoled Solodrive	0-10v	100% - 0%	Logarithmic Dimming Curve
L11	Lutron Hi-Lume Premier (PEQ0E) Max lumen package 03	0-10v	100% - 0.1%	Hi-lume Premier 0.1% EcoSystem LED driver with Soft-on, Fade-to-Black dimming technology
L15	Lutron Hi-Lume Series (LDE1)	0-10v	100% - 1%	Hi-Lume 1% EcoSystem LED driver with Soft-on, Fade-to-Black dimming technology
ELE	Eldoled Ecodrive	DALI	100% - 1%	Logarithmic Dimming Curve
ELS	Eldoled Solodrive	DALI	100% -0%	Logarithmic Dimming Curve

**CROSS SECTIONS**

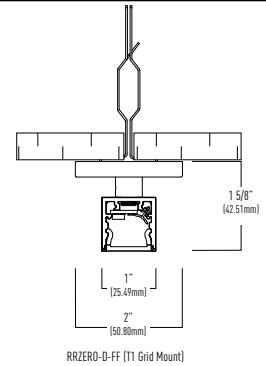
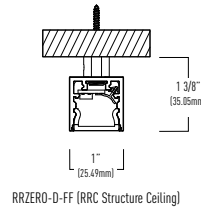
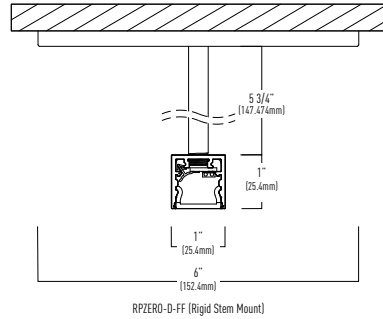
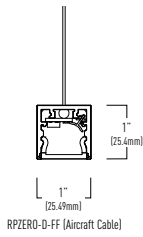

**T-BAR MOUNTING HEIGHT**

**1" Grid Detail**

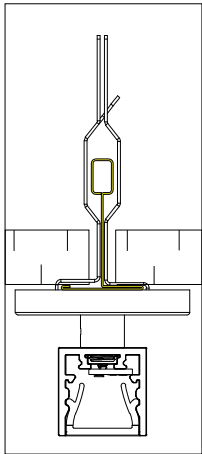

Standard Tile - 1-1/2" "T" height & supported by grid hook extension

**9/16" Grid Detail**

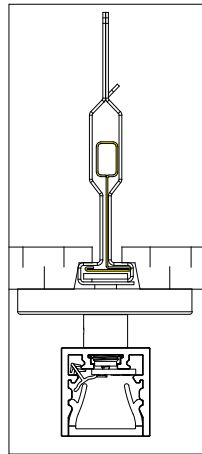

Tegular Tile

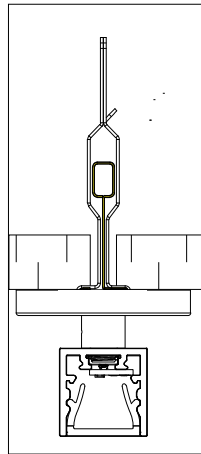

Standard Tile

**Screw Slot Detail**

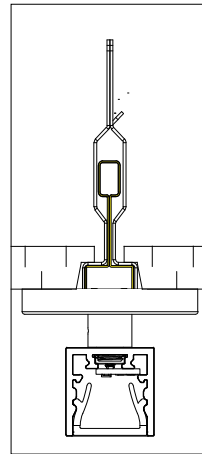

Tegular Tile

**FIXTURE FINISH**

Regolo Zero is available in three standard powder coat painted finishes including White Painted Finish **(WH)**, Silver Painted Finish **(SV)**, Black Painted Finish **(BK)** and Custom Color Painted Finish **(CC)**.

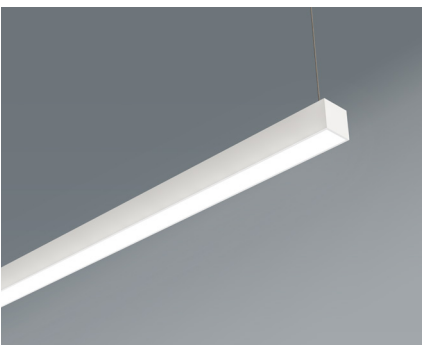

**WH** - White Painted Finish

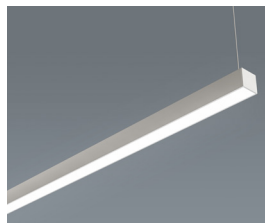

**SV** - Silver Painted Finish

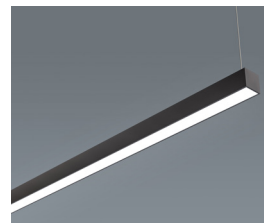

**BK** - Black Painted Finish

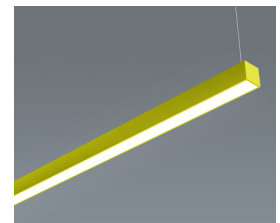

**CC** - Custom Color Painted Finish

Regolo Zero Surface Mount is available in three standard powder coat painted finishes including White Painted Finish **(WH)**, Silver Painted Finish **(SV)**, Black Painted Finish **(BK)** and Custom Color Painted Finish **(CC)**.



**WH** - White Painted Finish



**SV** - Silver Painted Finish

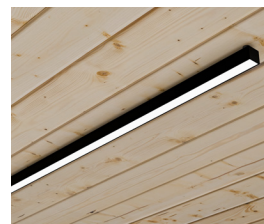

**BK** - Black Painted Finish

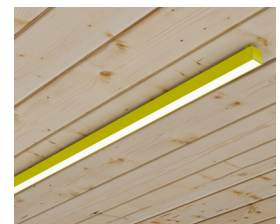

**CC** - Custom Color Painted Finish

**END CAPS**

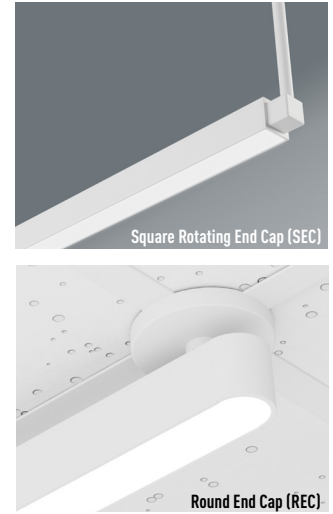
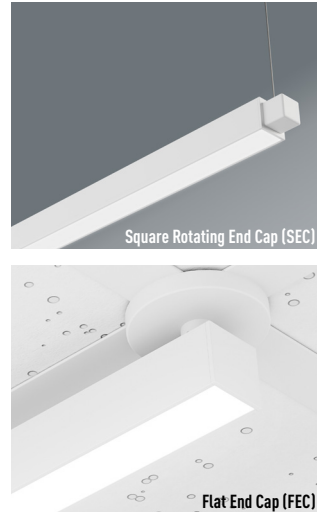
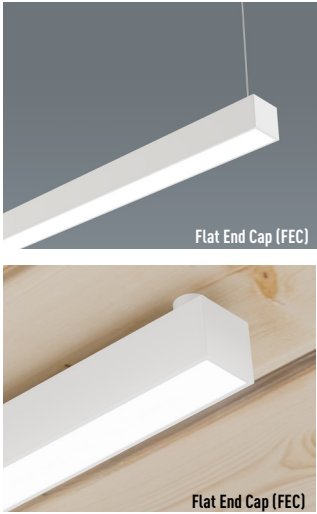

**SHIELDING**



**CONTINUOUS LENS**

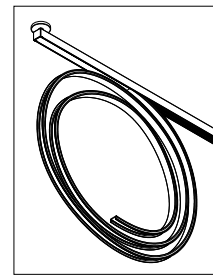

**Continuous Lens (CL)**

The Regolo Zero series is available with a continuous lens option that eliminates lens gaps and provides seamless uniform illumination for linear lengths up to 40'.

**SQUARE ROTATING END CAP (PENDANT) AIMING DETAIL**

Freely adjust luminaires directional distribution with 359° of rotational tilt between mounting points. Secure desired beam angle using set screws.

**Square Rotating End Cap Example**

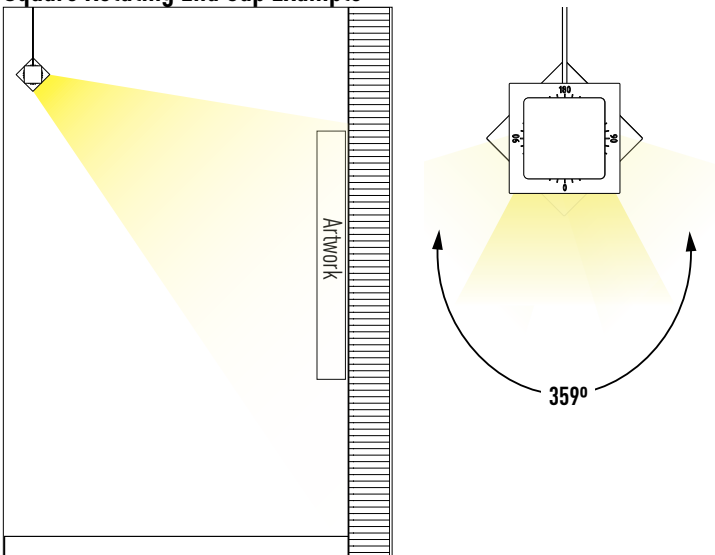

**SQUARE ROTATING END CAP (SURFACE) AIMING DETAIL**

Freely adjust luminaires directional distribution with 359° of rotational tilt between mounting points. Secure desired beam angle using set screws.

**Square Rotating End Cap Example**

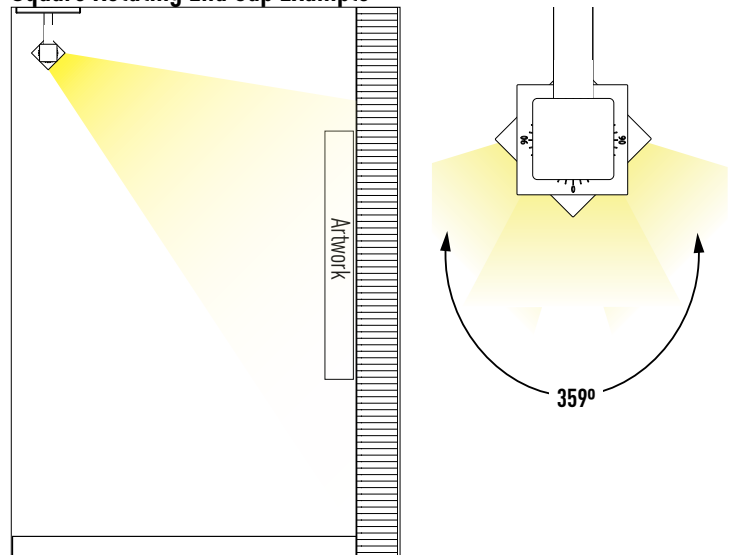



**NuLoc™**

Introducing the latest in linear LED lighting innovation: Regolo Zero is Nulite's first fixture series to feature the groundbreaking patent pending NuLoc™ joining technology. This revolutionary design redefines how lighting fixtures connect and perform, offering unparalleled functionality and aesthetic appeal.

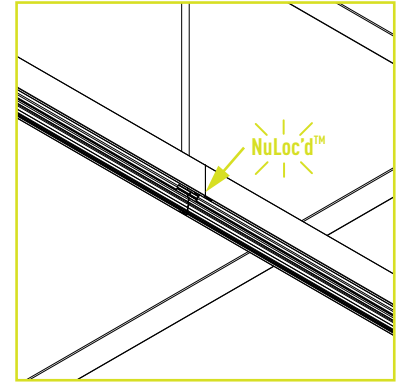
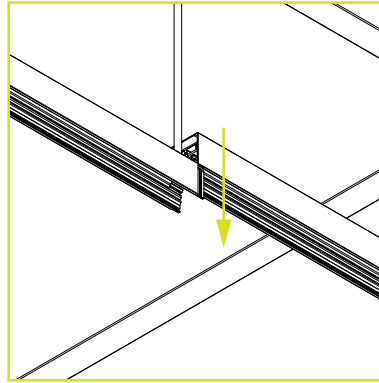
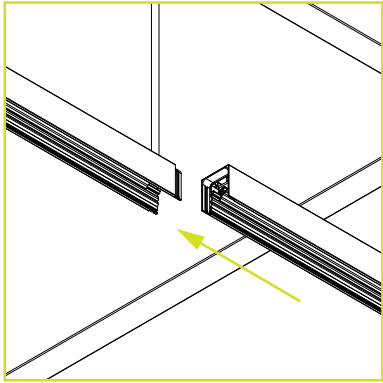

**Effortless Integration**

The innovative NuLoc™ system eliminates the need for hardware or tools, simplifying installation while preserving design integrity.

**Flawless Aesthetics**

Seamlessly connect fixtures for continuous runs, unique configurations, and intricate shapes, all without compromising light quality.

**Zero Light Leaks**

Achieve a monolithic appearance, uniform illumination with precision-engineered lensing for a polished, professional look.

**PIVOT JOINT**

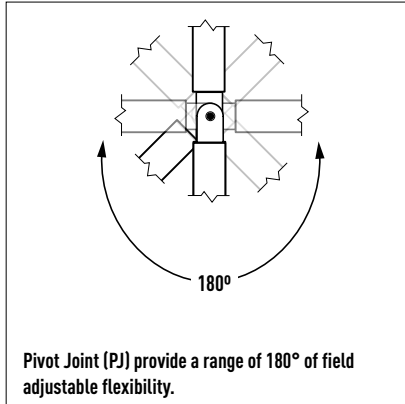

Regolo Zero can be joined together using Pivot Joint (PJ) to create longer runs or custom configurations. Each Pivot Joint has 180° of variability and is installed with powered suspension points. Pivot Joints are available in pre-set standardized angles including 90°, 105°, 120°, 135°, 150°, and 180°. Pivot Joint are also field adjustable to fit a desired angle using field adjustable set screws.

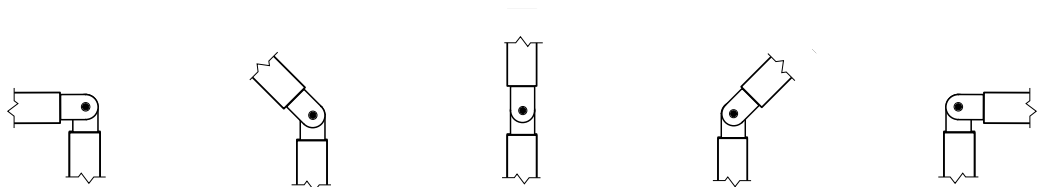

**CURVED JOINT**

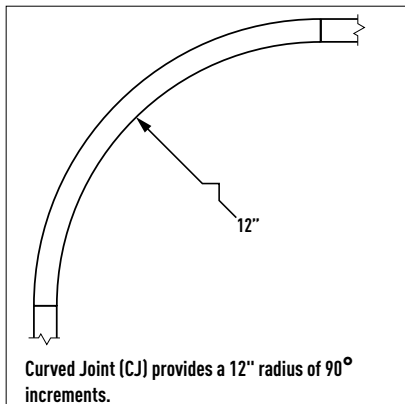

Regolo Zero can be joined together using Curved Joint (CJ) to create soft corners, ovals or custom configurations. Each Curved Joint has a 12" of 90° of radial direction change or 24" of 180° of radial direction change. Curved Joints are installed with one powered suspension point each.

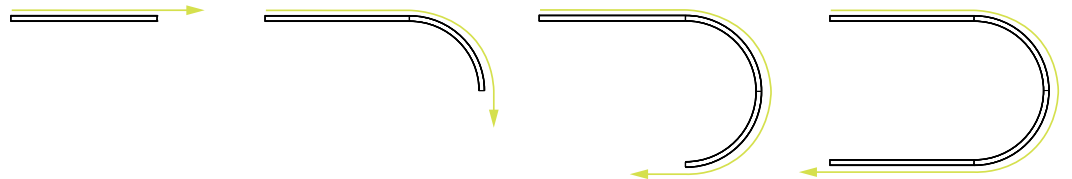

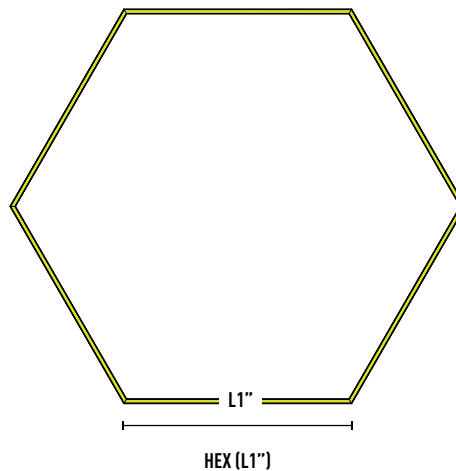
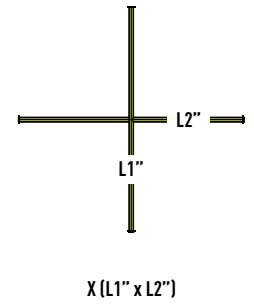
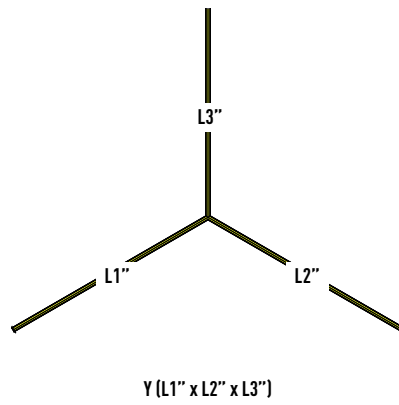
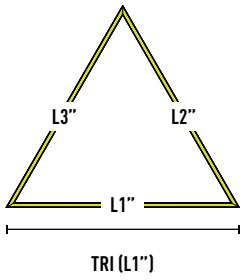
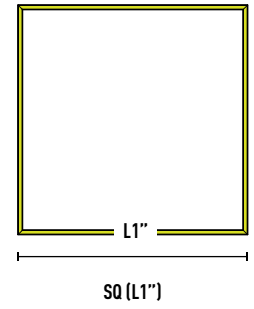
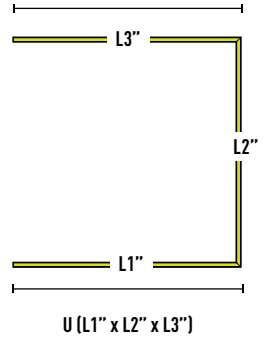
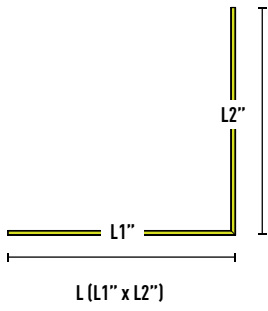

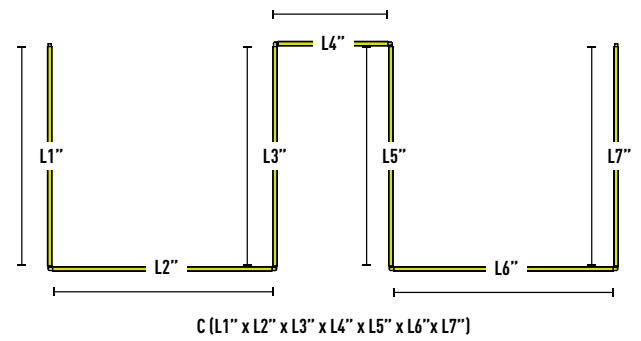
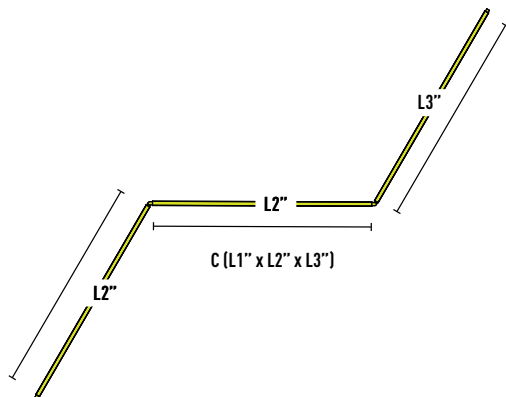
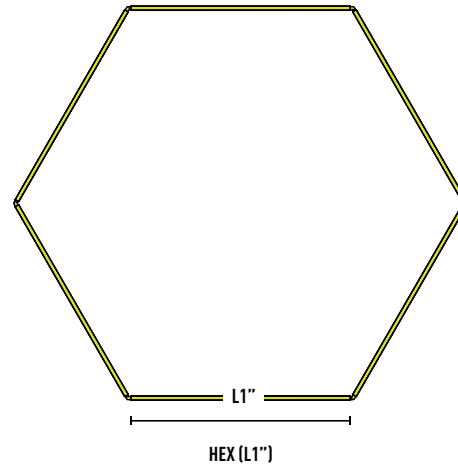
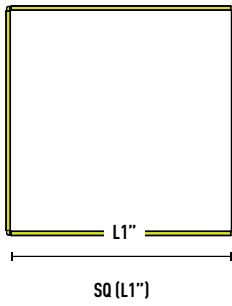
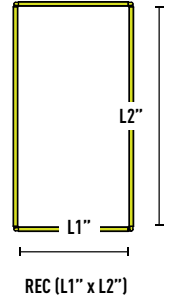
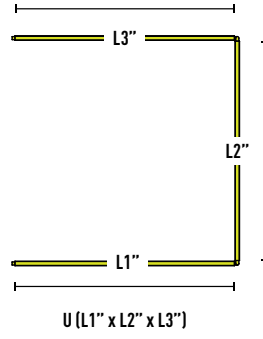
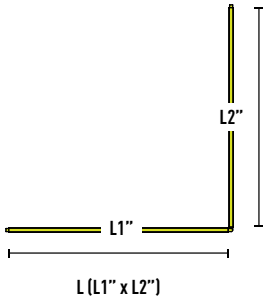

**CURVED SHAPES**

CONFIGURE SHAPES USING THE CURVED JOINTS

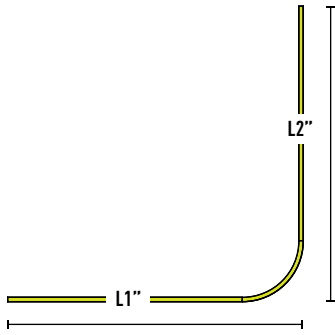

L (L1" x L2")

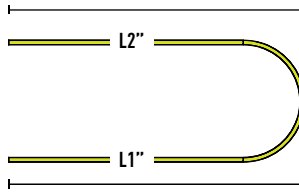

U (L1" x L2")

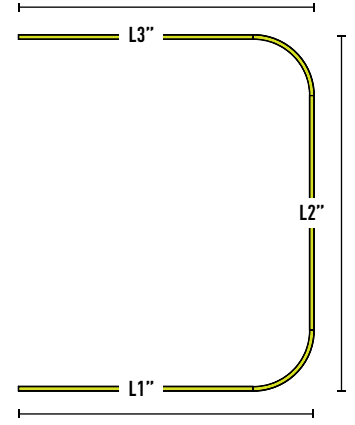

U (L1" x L2" L3")

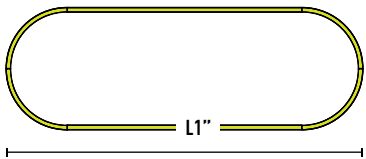

O (L1")

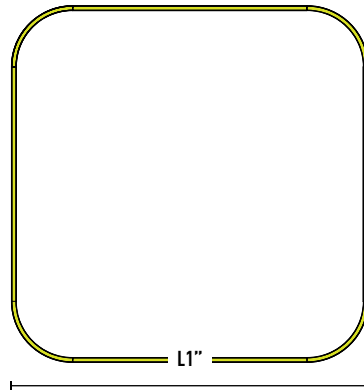

SQ (L1")

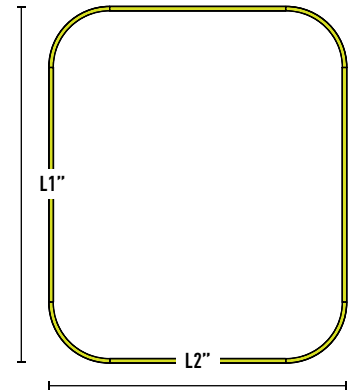

RECT (L1" x L2")

**CURVED CUSTOM SHAPES (EXAMPLES)**

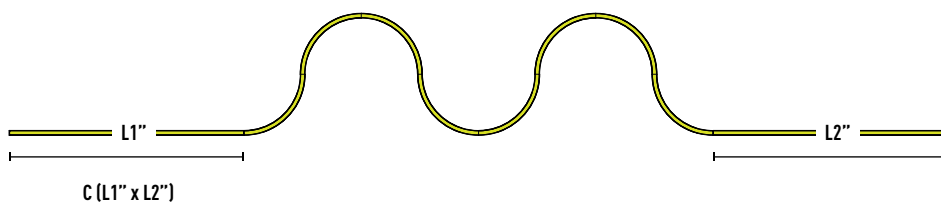

C (L1" x L2")



**REGOLO ZERO CREATIVE CONFIGURATION**

Using the example shown below, use the following page to sketch and label a view of your desired Regolo Zero configuration. Once you've drawn and labeled your custom shape it can be scanned and sent to the Nulite via email: [cs@nulite.lighting](mailto:cs@nulite.lighting). Nulite's customer service team will work on creating custom factory drawings of your desired Regolo Zero configuration.

**Designer Sketch Example:**

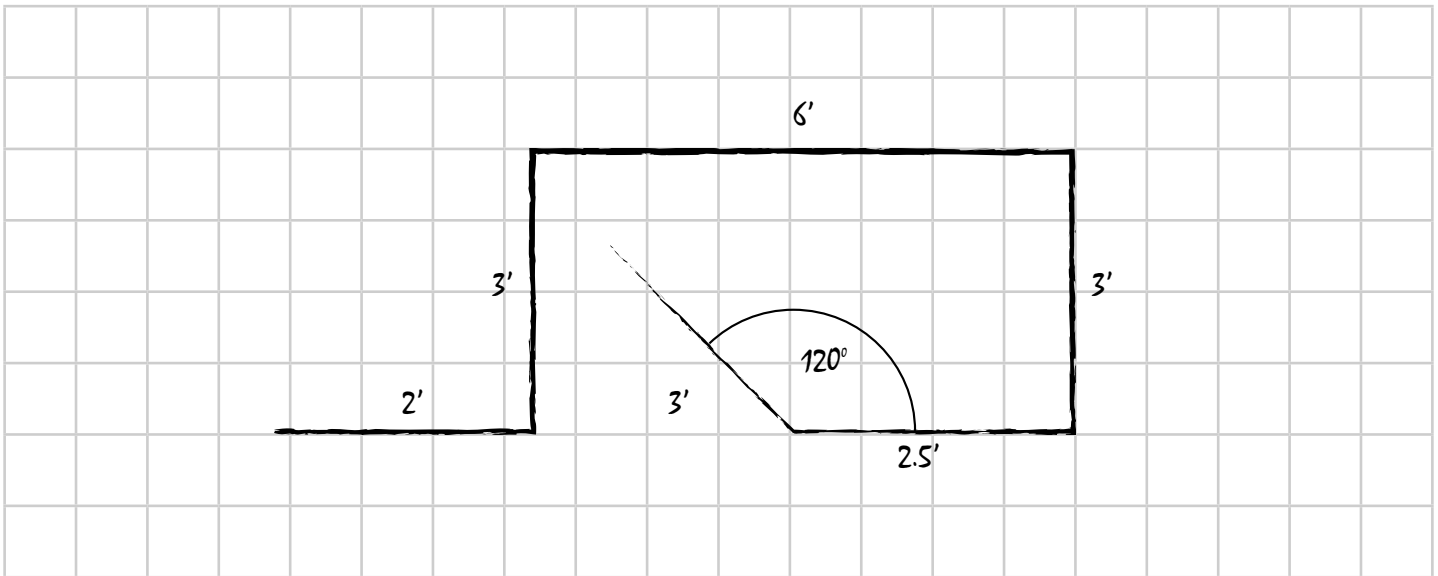

**Layout Example:**

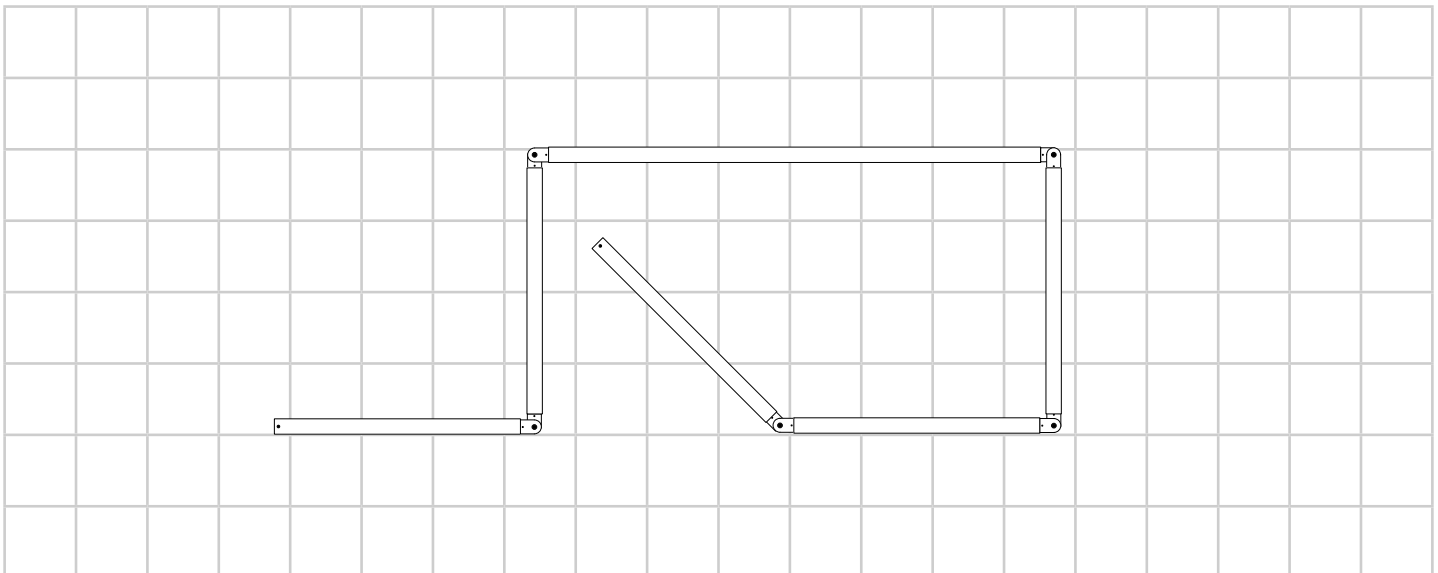

**REGOLO ZERO CREATIVE CONFIGURATION**

Once you've drawn and labeled your custom shape it can be scanned and sent to the Nulite via email: [cs@nulite.lighting](mailto:cs@nulite.lighting). Nulite's customer service team will work on creating custom factory drawings of your desired Regolo Zero configuration.

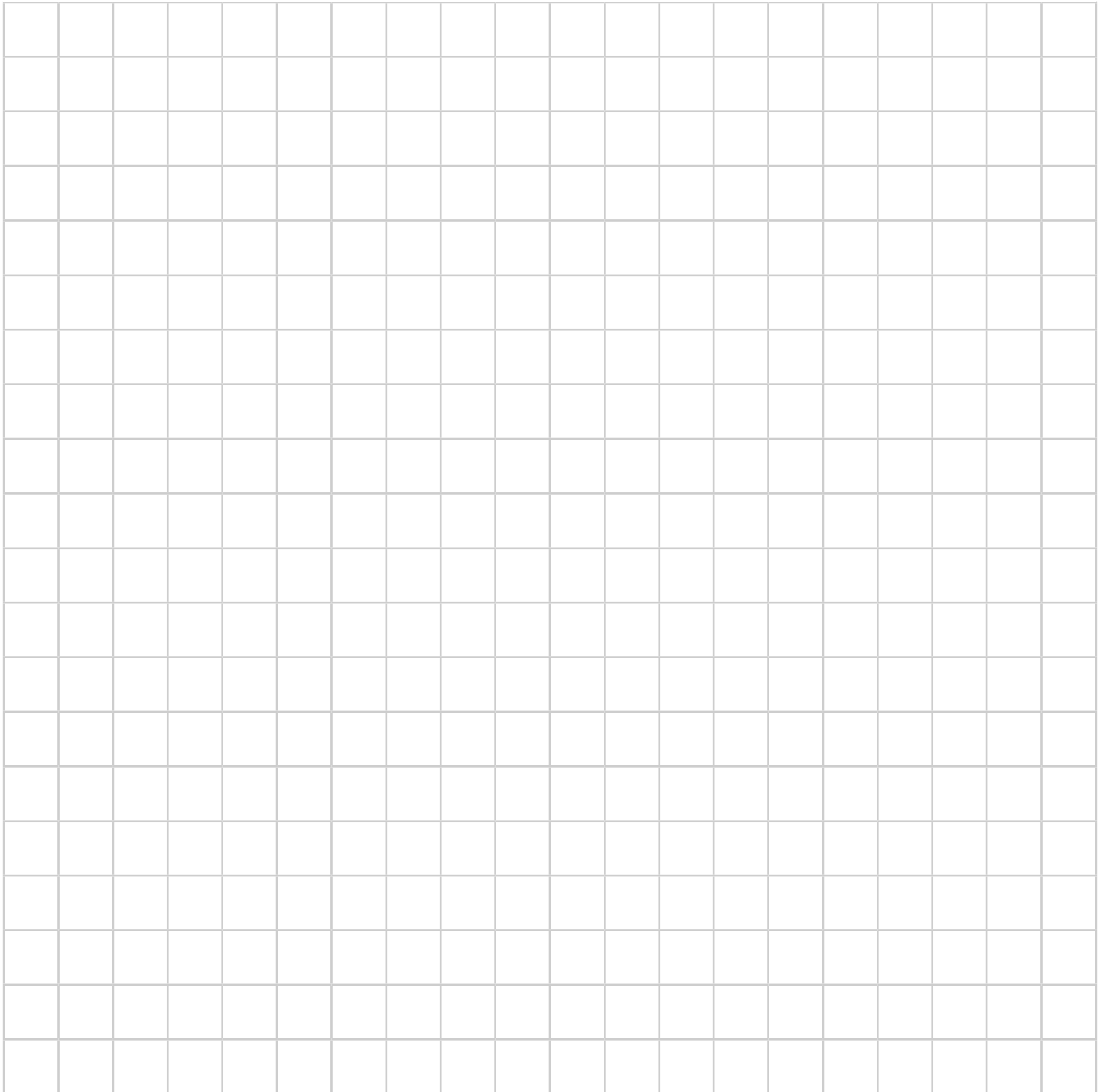

## PRODUCT SPECIFICATIONS AND INFORMATION

### HOUSING CONSTRUCTION

Luminaire housing is up to 70% recycled content constructed of extruded aluminum with machined aluminum or die cast zinc end caps. All hardware is stainless steel. Row and pivot joint components are machined or die cast aluminum.

Remote grid mounted driver enclosures (**T1/T9/TS/ T1R/T9R/TSR**) and canopy integrated power supply (**GP**) are constructed out of die-formed galvanized steel.

### LEDS AND OPTICAL SYSTEM

Frosted Flush Lenses (**FF**) and Black Flush Lenses (**BF**) are co-extruded frosted acrylic with matte white reflector for even illumination.

Regolo Zero LA Series (**55B/55W/65B/65W**) low glare optic system offer beam patterns from 55° -65° and asymmetric distributions, utilizing optical grade acrylic TIR lenses.

### STANDARD DIMMING LED DRIVERS

Standard constant current remote electronic 0-10v dimming input. Two standard driver options are available. Option (**D**) dims to 1% and option (**DO**) dims to 0% or OFF (the final 1 percent is a "step"). Both options are the same price and representative of the base fixture price. Options (**D**) and (**DO**) ship with 5 wires (Line Voltage- Black and White Wires, Low Voltage- Purple and Pink Wires, Ground- Green Wire)

### DALI DRIVERS

Standard constant current DALI drivers available in either a dim to 1% (**ELE**) or dim to 0% (**ELS**). DALI fixtures ship with 5 wires (Line Voltage- Black and White Wires, Low Voltage- Purple and Pink Wires, Ground- Green Wire)

### LIGHT OUTPUT

Standard factory set light outputs are programmed to within +/- 5% of the nominal light level at 3500K 80 CRI LEDs. Light output, wattage, and efficacy will vary across different CRI's CCT's. Refer to ies files on the website for actual detailed lighting performance data.

### CIRCUITING

Each luminaire may have up to 1 line voltage (Power) circuits and 1 low voltage (Control) circuits. Two power circuits are required for independent control of left and right sections in linear luminaires, and low voltage control circuits are required for independent dimming of each circuit.

#### Examples:

- "1-1"- 1 power circuit (Line Voltage) and 1 control circuit (Low Voltage) > 5 wires total (1 Black Wire "Hot", 1 White Wire "Neutral", 1 Green Wire "Ground", and 2 low voltage control wires, 1 Pink Wire and 1 Purple Wire)

### BATTERY PACKS

Maintenance free lithium ion battery pack, battery run time is 90 minutes. Recharge time of 24 hours. 10 Watt Battery Pack (**10W**) or 15 Watt Battery Pack (**15W**) are available. To calculate Battery Lumen Output, multiply luminaire efficacy by battery wattage. (example: 110 lms/watt (120) x B10 Battery Wattage (10) = 1100 lumens of egress illumination for 90 minutes.)

Battery options are not available in fixtures less than 4', and other limitations apply, consult factory. Entire "direct" luminaire housing is energized by battery for lengths up to 5'. 4' sections of luminaire of direct fixtures are energized by battery for 6' - 8' housing lengths. Emergency or night light circuit available (requires additional power circuit). Battery fixtures ship with an additional Orange "constant hot" Wire.

### LUMEN MAINTENANCE

90% of initial light output (L90) at 48,000+ hours, 70% of initial light output (L70) at 72,000+ hours.

### GENERATOR TRANSFER DEVICES

Generator Transfer Devices (**GTD**) emergency lighting control device senses the loss of normal power and switches the AC driver input power connection to a generator (or central inverter) supplied lighting circuit. When a Generator Transfer Device (**GTD**) is provided in a fixture it will ship with 3 additional wires (Orange Wire "constant hot", Black-Red Wire "generator hot", White-Red Wire "generator neutral").

### FIXTURE FINISH

Standard finishes are powder coat painted White Painted Finish (**WH**), Silver Painted Finish (**SV**) or Black Painted Finish (**BK**). Consult factory for Custom Color Painted Finish (**CC**).

### INSTALLATION AND MOUNTING

RPZERO mounts to acoustical grid ceilings (**T1/T9/TS**), various Structural Ceilings (**RR/RRC**) and Inaccessible Ceilings or Grid Ceilings (**GP**). RPZERO can utilize Square Rotating End Caps (**SEC**) which allows for adjustment of luminaires directional distribution with 359° of rotational tilt between mounting points. Luminaire power supplies are remote mounted above the ceiling or onto the ceiling surface. The maximum distance between a luminaire and remote driver enclosure is 25'. Each luminaire requires a dedicated remote power supply.

RPZERO is suspended using a adjustable Standard Aircraft Cable and a preattached Power Cord Suspension (**PC**) up to 240" from ceiling surface. RPZERO can also be suspended from Rigid Stem Suspension (**RS**) mounting points up to 12" from ceiling surface. Aircraft cables are 1mm stainless steel with nickel plated gripper at canopy. Rigid stems are 3/8" diameter steel tube finished with matte paint.

RPZERO can be individually mounted or continuously mounted in linear configurations or complex patterns. Refer to data sheets and installation instructions for details on fixture dimensions, mounting location dimensions and available luminaire configurations.

RRZERO is designed to be surface mounted to an architectural building surface. The fixture must be secured to structure at specific locations along the fixture length and power must be also be roughed in at specific locations prior to installation. RRZERO may be individually mounted or continuously mounted in linear configurations or complex geometric patterns. Refer to installation instructions at [nulite.lighting](http://nulite.lighting) for details.

### WARRANTY

5-year limited warranty on LED and driver from date of shipment. Refer to the full warranty details on [nulite.lighting](http://nulite.lighting).

### WEIGHT

Pendant mounted luminaire weight is 0.5 lbs/ft, Remote power supply weights vary per remote driver enclosure type and electrical configuration, consult factory.

### APPROVALS

ETL listed, conforms to UL standard 1598 / 8750 and CSA standard C22.2, indoor dry/damp locations.

### TESTING AND CERTIFICATION

All of Nulite's LED components have been tested under LM-80 guidelines insuring 6000 hours of luminous flux data. Additionally Nulite can supply LM-79 data on all luminaires. This data includes luminous flux, electrical power, efficiency, chromatically as well as the diffusion of luminous intensity.