

CAROUSEL SEATING

Carousel Seating offers a durable, low-maintenance solution for urban spaces. Made from powder-coated marine-grade aluminum, with optional timber inlay, it supports ADA-compliant and wheelchair accessible layouts offering flexible configurations for multi-purpose use.



PICTURED CONFIGURATION

5052 Aluminum
6 Seater with Low-Back Seat
AAMA 2604 Powder Coated
Aluminum

SPECIFICATIONS

Aluminum or Timber Inlay
Circular Table Top
2-6 Seater Arrangements
with ADA and Wheelchair
Accessible (WCA) Spots
Seat Backrest Options

OVERVIEW

Marine-Grade Aluminum
AAMA 2604 Powder Coated Inside
and Out
Thermally Modified Ash or Recycled
Plastic Lumber Inlay Options
Variable Seating Arrangements
Seat Backrest Options
Umbrella Holder

SIZE / SEATS

2 Seater with 2 WCA Spots

87" x 42" x 30"
Ø 42"

3 Seater with 1 ADA Spot

87" x 87" x 30"
Ø 42"

4 Seater

87" x 87" x 30"
Ø 42"

5 Seater with 1 WCA Spot

87" x 72" x 30"
Ø 47"

6 Seater

96" x 96" x 30"
Ø 47"

GreenTheory™

INFO@GREENTHEORY.COM
+1.844.747.9283

greentheory.com

©2026 Green Theory Design

MATERIAL

5052 Aluminum

SEATING OPTIONS

- CARM4-2-2W**
2 Seater with 2 WCA Spots
- CARM4-2-3A**
3 Seater with 1 ADA Spot
- CARM4-2-4**
4 Seater
- CARM4-3-5W**
5 Seater with 1 WCA Spot
- CARM4-3-6**
6 Seater

SEAT BACKREST OPTIONS

- Backless
- Low-back
- Backed

POWDER COAT OPTIONS

- Matte Black
- Matte White
- Pewter
- Rust
- Suede Bronze
- Almond
- Metallic Silver
- Smokey Beige
- Aged Copper
- Custom RAL

CAROUSEL SEATING ALUMINUM

CURRENT SPECIFICATION

Aluminum
4 Seater with Low-Back Seat

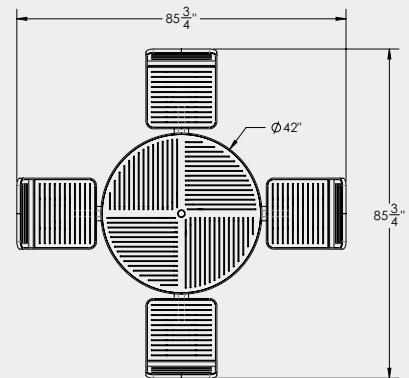

INSTALLATION DETAIL

3 x 0.50" Dia., Masonry Anchor
per Leg (supplied by others)

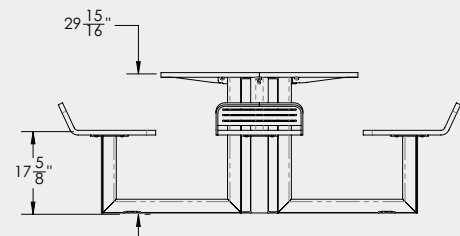

Aluminum 2 Seater
with 2 WCA spots

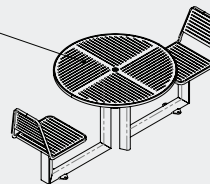

Aluminum
Backless Seat

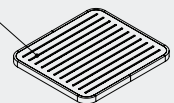

Aluminum 3 Seater
with 1 ADA Spot

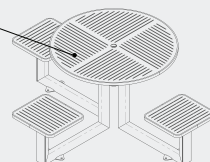

Aluminum
Low-Back Seat

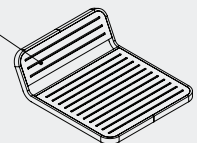

Aluminum 6 Seater

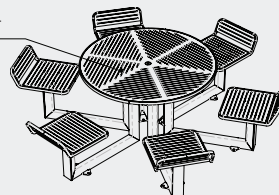

Aluminum
Backed Seat

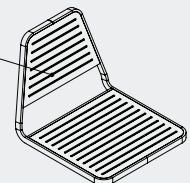

GreenTheory™

INFO@GREENTHEORY.COM
+1.844.747.9283

greentheory.com

Date: 12 10 2025
Specification Sheet Version 1.1A

Green Theory reserves the right to revise technical specifications at any time without prior notice. Correct mounting hardware and the method of mounting of the product are imperative to user safety. Use installation instructions to correctly position and install product.

©2026 Green Theory Design

MATERIAL OPTIONS

5052 Aluminum

- Thermally Modified Ash
- Recycled Lumber

SEATING OPTIONS

- CART4-2-2W**
2 Seater with 2 WCA Spots
- CART4-2-3A**
3 Seater with 1 ADA Spot
- CART4-2-4**
4 Seater
- CART4-3-5W**
5 Seater with 1 WCA Spot
- CART4-3-6**
6 Seater

SEAT BACKREST OPTIONS

- Backless
- Low-back
- Backed

POWDER COAT OPTIONS

- Matte Black
- Matte White
- Pewter
- Rust
- Suede Bronze
- Almond
- Metallic Silver
- Smokey Beige
- Aged Copper
- Custom RAL _____

Green Theory™

INFO@GREENTHEORY.COM
+1.844.747.9283

greentheory.com

Date: 12 10 2025
Specification Sheet Version 1.1A

Green Theory reserves the right to revise technical specifications at any time without prior notice. Correct mounting hardware and the method of mounting of the product are imperative to user safety. Use installation instructions to correctly position and install product.

©2026 Green Theory Design

CAROUSEL SEATING

TIMBER INLAY

CURRENT SPECIFICATION

Timber Inlay
4 Seater with Low-back seat

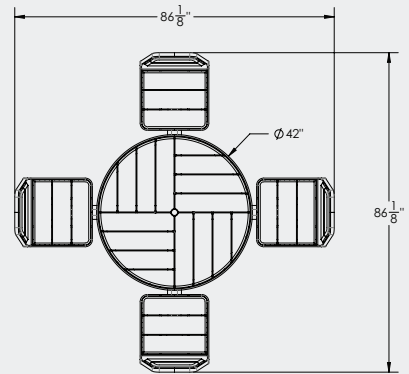

INSTALLATION DETAIL

3 x 0.50" Dia., Masonry Anchor
per Leg (supplied by others)

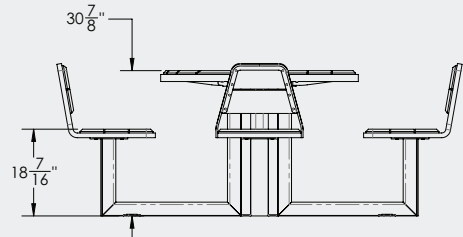

Timber Inlay 2 Seater
with 2 WCA spots

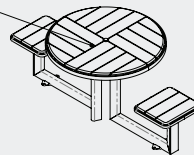

Timber Inlay
Backless Seat

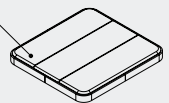

Timber Inlay 3 Seater
with 1 ADA Spot

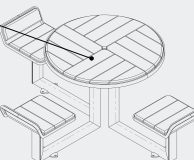

Timber Inlay
Low-Back Seat

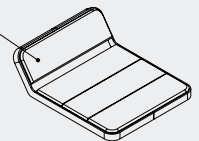

Timber Inlay 6 Seater

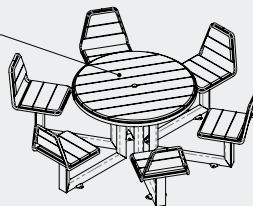

Timber Inlay
Backed Seat

