

BALANCING VALVES

DN 200–400

Adjustment Instructions

Balancing valves
Adjustment Instructions

Linjasäätöventtiilit
säätöohje

Kulowe zawory
regulacyjne
Instrukcja montażu i
doboru nastawy

Injusteringsventiler
Inställningsanvisning

Regulier-kugelhähne
Regulierungsanweisung

Шаровой кран регулировочный
Инструкция по регулировке

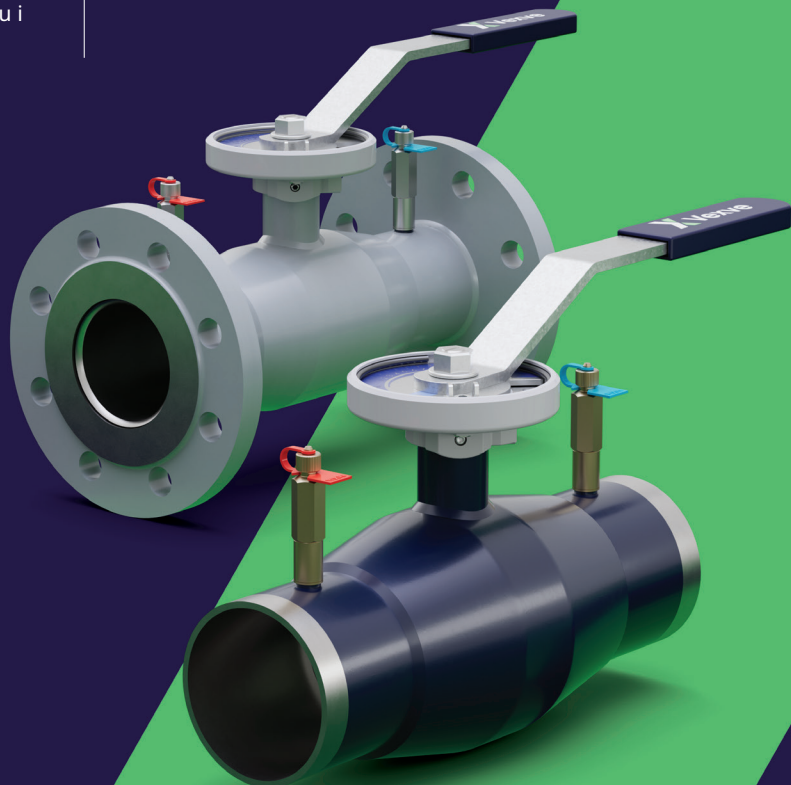

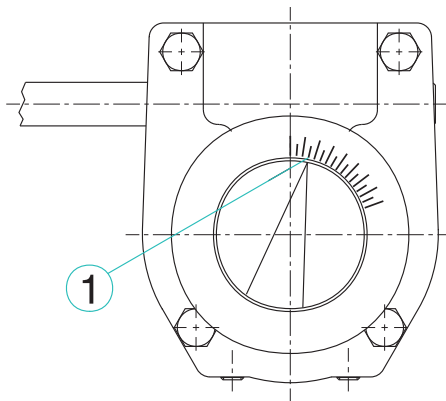

Esisäätöarvon asetus:

Aseta haluttu esisäätöarvo (1)

Inställning av förinställningsvärde:

Ställ in ventilen tili önskat förinställningsvärde (1)

Kolejność działań przy doborze nastawy:

Wybrać odpowiednią wartość nastawy (1)

Setting of preadjustment values:

Set the desired preadjustment value (1)

Einrichtung der Voreinstellungswert:

Stellen Sie den von Ihnen gewünschten Voreinstellungswert ein (1)

Установка параметра регу лировки:

Поворотом рукоятки установите желаемое значение параметра регулировки расхода (1)

Kv-values for Vexve balancing valves

Set value	DN 15/20	DN 25	DN 32	DN 40	DN 50	DN 65	DN 80	DN 100	DN 125	DN 150	DN 200	DN 250	DN 300	DN 350	DN 400
1,0	-	-	0,39	0,60	1,26	2,52	3,42	6,48	6,84	13,68	19,7	35,0	54,5	124,0	162,41
1,5	-	0,35	0,57	1,01	1,80	3,64	5,37	9,47	13,32	20,16	20,2	51,2	80,0	203,0	242,10
2,0	0,14	0,49	0,83	1,48	2,70	4,75	7,31	12,46	18,00	26,64	38,4	66,5	105,0	282,0	362,35
2,5	0,28	0,99	1,08	2,02	3,55	6,34	10,23	16,28	24,30	35,46	51,1	90,0	142,0	358,0	428,80
3,0	0,42	1,36	1,44	2,70	4,39	7,92	13,14	20,09	30,60	44,28	63,8	110,0	176,0	434,0	551,90
3,5	0,61	1,66	1,80	3,24	5,61	9,78	16,11	24,45	37,80	55,08	79,3	140,0	220,0	534,0	664,72
4,0	0,80	2,00	2,30	3,96	6,84	11,63	19,08	28,84	45,00	65,88	95,0	165,0	260,0	633,0	810,48
4,5	1,02	2,40	2,74	4,86	8,34	14,15	23,31	35,82	55,26	84,06	121,0	215,0	336,0	779,0	969,90
5,0	1,24	3,00	3,42	5,98	9,83	16,67	27,54	42,84	65,52	102,24	147,0	260,0	408,0	925,0	1194,05
5,5	1,64	3,50	4,21	7,18	11,94	20,94	33,21	51,84	81,72	127,08	183,0	325,0	510,0	1132,0	1420,20
6,0	2,04	4,50	5,11	8,57	14,04	25,20	38,88	60,84	97,92	151,92	219,0	380,0	600,0	1339,0	1744,32
6,5	2,64	5,10	5,97	10,15	16,92	29,52	46,26	75,42	121,86	196,56	282,0	500,0	785,0	1636,0	2109,90
7,0	3,24	6,70	7,27	12,31	19,80	33,84	53,64	90,00	145,80	241,20	325,0	576,0	950,0	1932,0	2636,09
7,5	3,84	7,30	8,64	14,40	23,40	39,78	64,62	113,40	177,30	289,80	417,0	740,0	1156,0	2460,0	3380,50
8,0	4,45	9,30	10,08	17,64	27,00	45,72	75,60	136,80	208,80	338,40	486,0	866,0	1353,0	2988,0	4190,88
8,5	5,04	10,00	11,52	20,88	30,60	53,46	91,80	169,20	251,30	399,80	576,0	1020,0	1594,0	3958,0	5545,25
9,0	5,83	12,65	13,14	22,57	34,20	61,20	108,00	216,00	293,80	460,80	660,0	1170,0	1840,0	4928,0	7159,35

DN 200

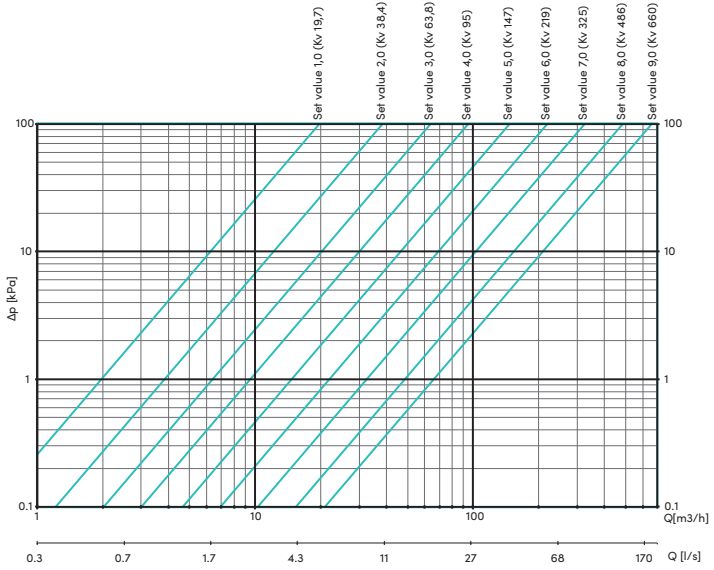

DN 250

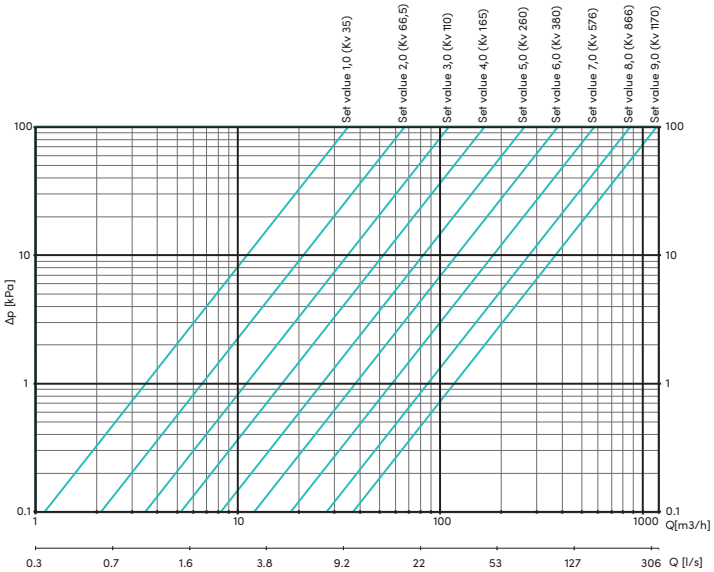

DN 300

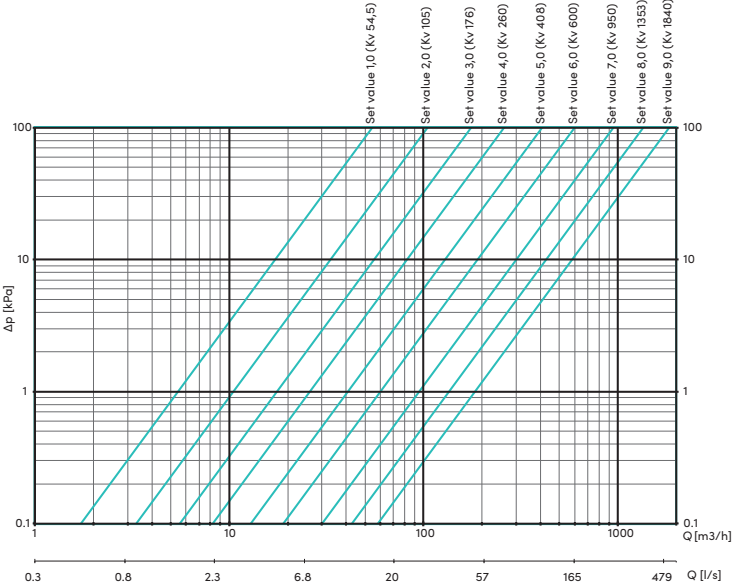

DN 350

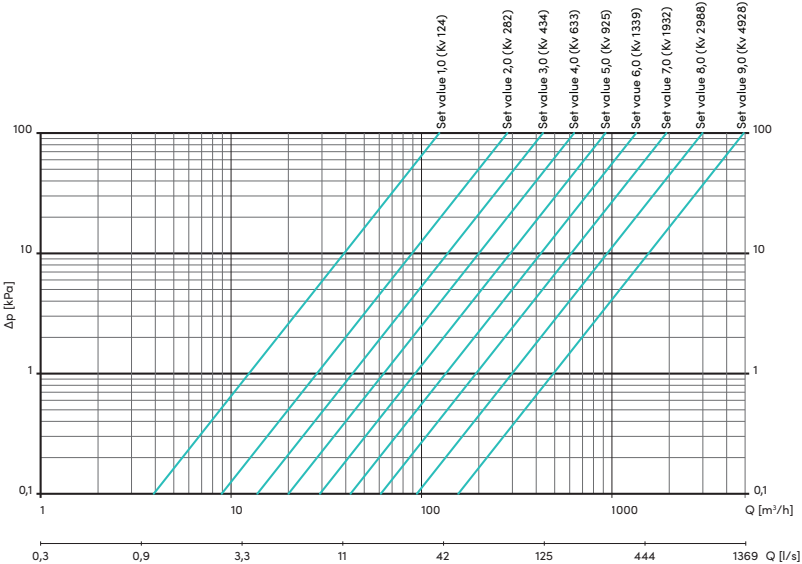

DN 400

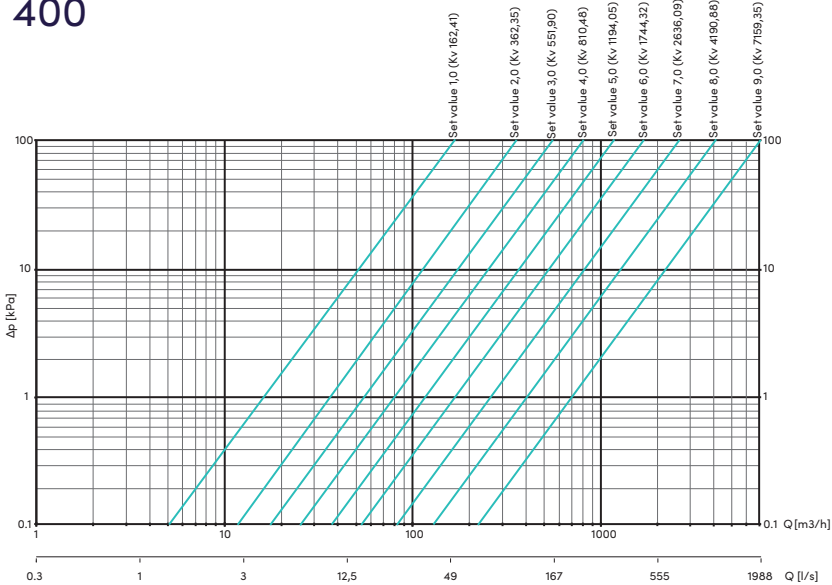



Vexve Oy
Pajakatu 11
38200 Sastamala
Finland

Riihenkalliontie 10
23800 Laitila
Finland

Tel. +358 10 734 0800
vexve.customer@vexve.com

