

16 Gage Steel

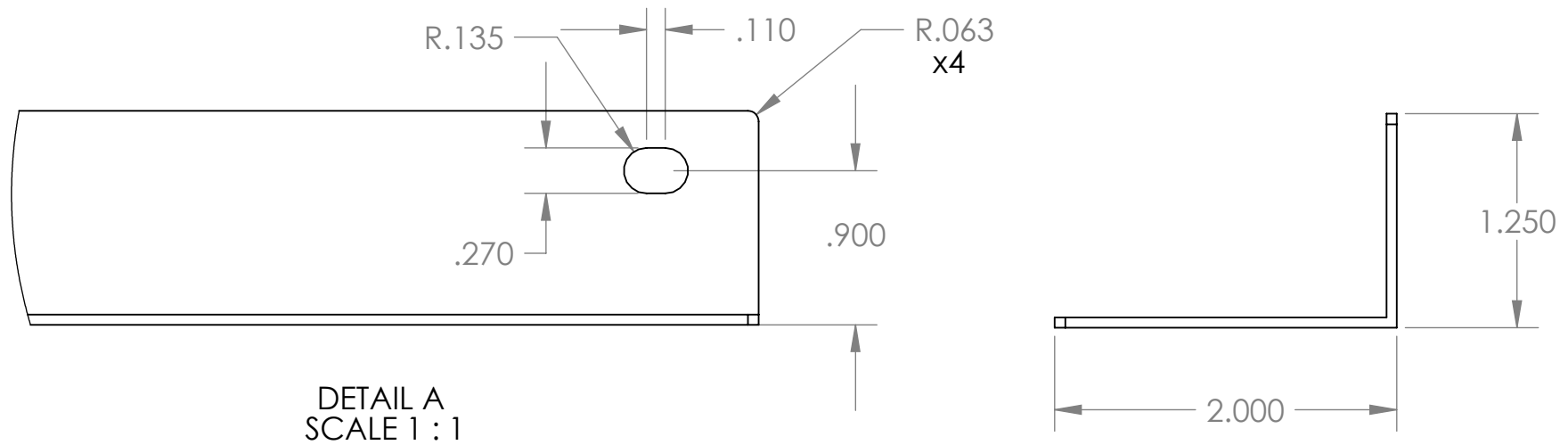

HM-308 Rail

434 West Levers Place
Orange, CA 92867
Phone: (714) 637-1252
Fax: (714) 637-0491
<http://www.skbcases.com>

This drawing and all information details are the sole property of SKB Corporation, Orange CA. Any unauthorized use will be punished to the full extent of the law.

Case Series:

Case part#

Weight:

Dimensions (for reference only)

	Dimensions (for reference only)			
	Length left to right	Width front to back	Overall height	Base / Lid height
Exterior				
Inerior				