

prawy/right

lewy/left

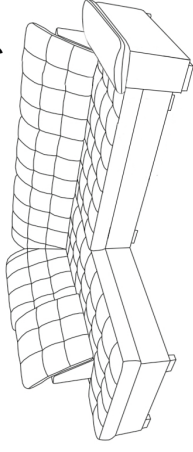

# BOSSL

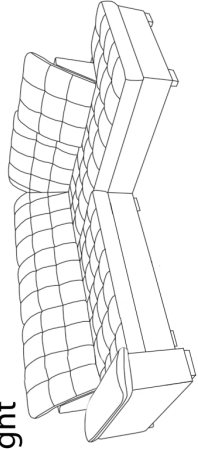
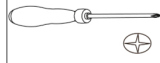

**A** H 5cm  
x 7

**B** x 3

**C** 45 mm  
złote  
x 13

prawy/right

lewy/left

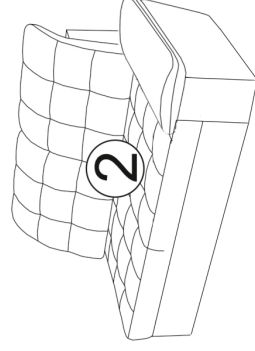
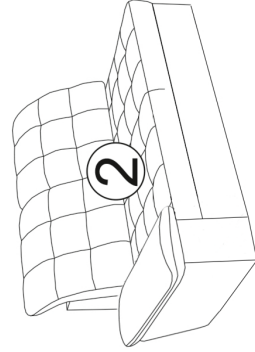
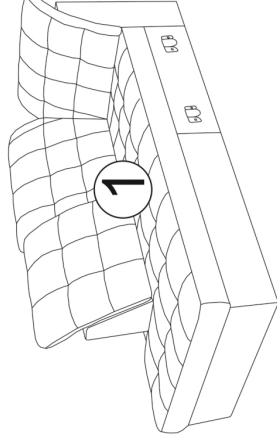
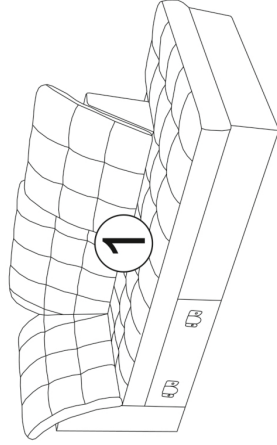

prawy/right

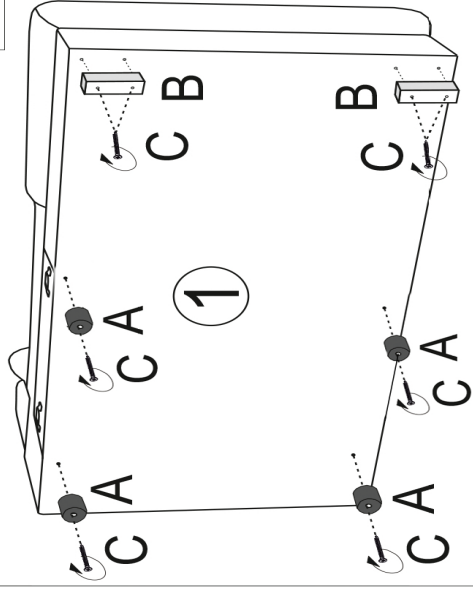
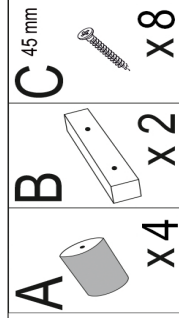

lewy/left

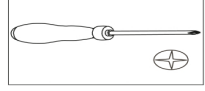
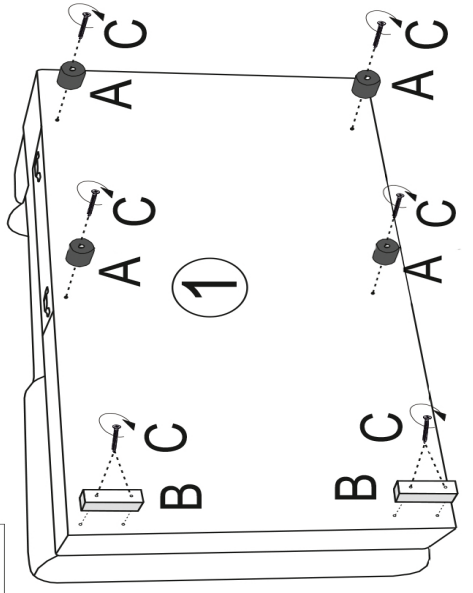

prawy/right

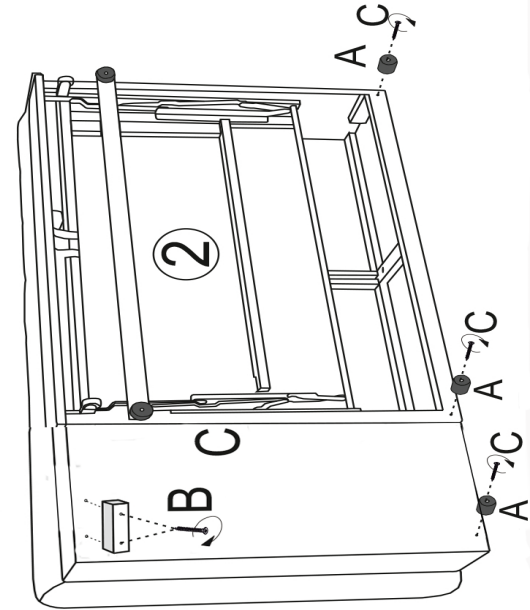

lewy/left

