

Operation and Maintenance of Water Supply Schemes

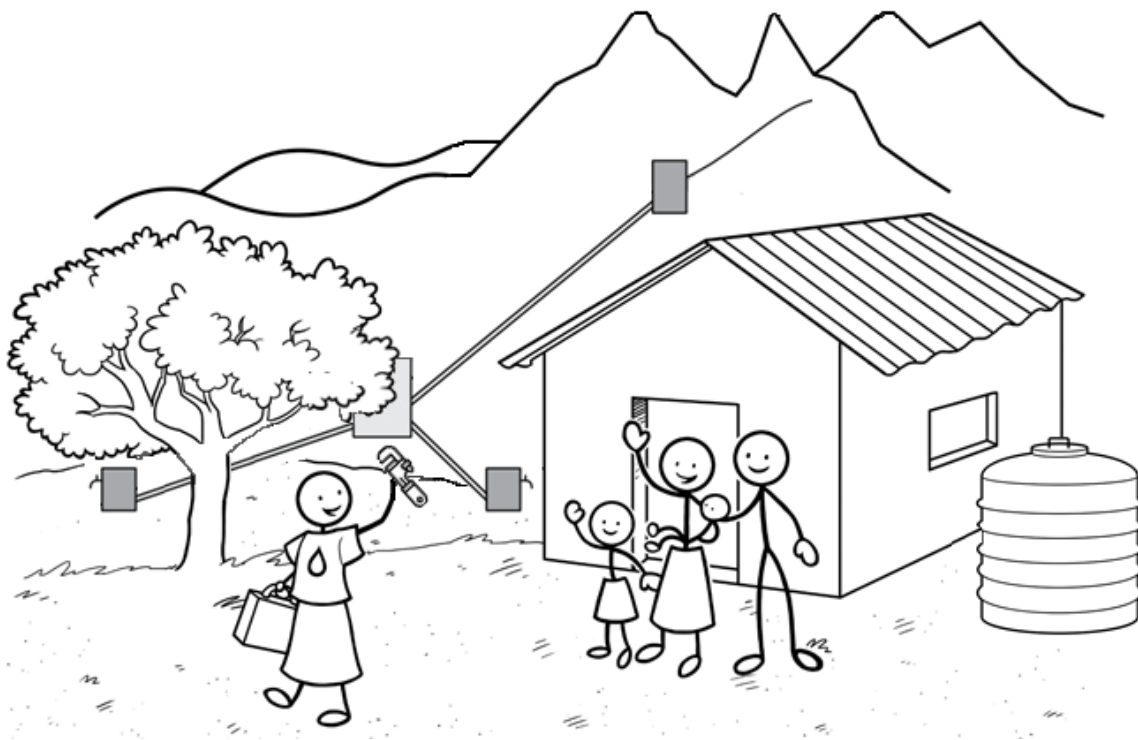

110/25 Adarsha Marg, New Baneshwor G.P.O Box 4102, Kathmandu, Nepal

Tel: 977-1-4468641/4493188 Fax: 977-1-4491376

Email: enpho@enpho.org Website: www.enpho.org

Established in 1990, ENPHO is a service-oriented, scientific, national non-governmental organization that envisages contributing in sustainable community development by combining research and actions through the integrated programs in the areas of environment and public health.

ENPHO runs a government accredited laboratory and promotes eco-friendly technologies such as SODIS, ECOSAN toilets, and wastewater treatment through reed bed systems.

ENPHO develops and promotes integrated community based approaches endorsing safe water, sustainable sanitation, solid waste management, hygiene behaviour and improving indoor air, and environmental and air quality monitoring to create healthy societies. Furthermore, knowledge-based education and advocacy campaigns help to achieve ENPHO's mission.

If you would like support to use this curriculum effectively in your WASH program please contact the Training Centre at ENPHO.

Email: ashkumar.khaitu@enpho.org

ENPHO and its directors, employees, contractors, and volunteers do not assume any responsibility for and make no warranty with respect to the results that may be obtained from the use of the information provided.



Upper 424 Aviation Road NE

Calgary, Alberta, T2E 8H6, Canada

Phone: + 1 403 243 3285, Fax: + 1 403 243 6199

E-mail: resources@kawst.org, Website: www.kawst.org

CAWST, the Centre for Affordable Water and Sanitation Technology, is a nonprofit organization that provides training and consulting to organizations working directly with populations in developing countries who lack access to clean water and basic sanitation.

One of CAWST's core strategies is to make knowledge about water common knowledge. This is achieved, in part, by developing and freely distributing education materials with the intent of increasing the availability of information to those who need it most.

This document is open content and licensed under the Creative Commons Attribution 4.0 International License. To view a copy of this license, visit: <http://creativecommons.org/licenses/by/4.0/>.



You are free to:

- Share – Copy and redistribute the material in any medium or format
- Remix – Remix, transform, and build upon the material for any purpose, even commercially



Under the following terms:

- Attribution – You must give appropriate credit to CAWST, provide a link to the license, and indicate if changes were made. You may do so in any reasonable manner, but not in any way that suggests that CAWST endorses you or your use. Please include our website: www.cawst.org

CAWST will produce updated versions of this document periodically. For this reason, we do not recommend hosting this document to download from your website.



Stay up-to-date and get support:

- Latest updates to this document
- Other workshop and training related resources
- Support on using this document in your work

<http://resources.cawst.org>

CAWST and its directors, employees, contractors and volunteers do not assume any responsibility for, and make no warranty with respect to, the results that may be obtained from the use of the information provided.

Table of Contents

Introduction	vi
Workshop Overview	vi
1.1 Participatory Learning	vi
1.2 PowerPoint Presentations	vi
1.3 Learning Outcomes.....	vii
1.4 Agenda	ix
Lesson Plans	xi
Lesson Plan 1: Workshop Introduction	2
Lesson Plan 2: Introduction to Water Supply Schemes	6
Lesson Plan 3: Introduction to Operation and Maintenance	16
Lesson Plan 4: O&M Water Supply Schemes	22
Lesson Plan 5: Factors Affecting O&M.....	25
Lesson Plan 6: Sustainability Planning.....	40
Lesson Plan 7: Link to WASH 45 minutes	49
Lesson Plan 8: Creating O&M Plan.....	53
Lesson Plan 9: Practicing Operation and Maintenance Skills	59
Lesson Plan 10: Workshop Review and Closing	77
Lesson Plan: Day 1 Review	95
Lesson Plan: Day 2 Review	96

Introduction

This Trainer Manual is to support people who facilitate Operation and Maintenance of Water Supply Scheme workshops. It is based on research and practical experience of both, ENPHO, the Environment and Public Health Organization, and CAWST, the Centre for Water and Affordable Sanitation Technology. It has been developed specifically for the context of Nepal and the use of gravity-fed water supply schemes.

Workshop Overview

Upon completion of this workshop, participants will understand core knowledge, skills, and behaviors related to sustainable operation and maintenance of rural water supply schemes, in particular gravity-fed systems in the context of Nepal. Participants will explore a range of factors that influence successful operation and maintenance, practice planning and problem solving, and engage in practical skills development.

This workshop has been designed to address common issues of performance, efficiency, and sustainability of rural water supply services, and incorporates technical and managerial sessions to support and provide guidance for local authorities. The workshop begins by introducing water supply scheme structures and organization, then moves on to cover issues related to operation, maintenance, repairs, management, and sustainable planning.

This workshop is designed to take three days, however the last session in the agenda can be expanded in certain circumstances from an exercise into a site visit. If trainers wish to conduct a site visit with participants, it would expand the agenda by another half day.

1.1 Participatory Learning

Participatory approaches are widely used to engage and actively involve everyone in the workshop. Effective learning often comes from shared experiences and participants learning from each other. The participatory workshop includes theory, activities, role-play, demonstrations, open discussion, and case studies. Active participant engagement in all learning activities is encouraged.

1.2 PowerPoint Presentations

This workshop includes several PowerPoint presentations that can be used as a learning aid. For optimal learning, PowerPoint presentations should only be used as a supplemental tool to discussions and learning activities. If PowerPoint presentations are not used, alternate visual aids should be used while speaking to enhance learning. It has been shown that it is easiest to understand and remember information when learners see text with simple pictures. This is especially true for learners with lower reading and writing skills.



For optimal learning, PowerPoint presentations should only be used as a supplemental tool to discussions and learning activities.

You may want to alter or reorganize some of the slides. This is best done prior to printing any handouts for the participants. Keep in mind that if you add or delete slides, the slide numbers will change, shifting the content in the lesson plans. If changing the slide format or design, please take care to retain the embedded logos that indicate the workshop authors.

1.3 Learning Outcomes

The following learning outcomes describe what the participants will be able to do by the end of the workshop to demonstrate increased knowledge, improved skills, or changes in attitude. Each lesson plan refers to the specific learning outcomes covered in that lesson.

Table: Participant Learning Expectations

Lesson Plan #	Lesson Plan	Learning Outcomes
1	Workshop Introduction	<ol style="list-style-type: none"> 1. Describe the agenda for the workshop 2. Discuss how the group is expected to work together during the workshop 3. Discuss the group's expectations for the workshop
2	Introduction to water supply schemes	<ol style="list-style-type: none"> 1. Describe water supply schemes and types 2. List the parts of water supply schemes 3. Explain the role of a user committee
3	Introduction to Operation and Maintenance	<ol style="list-style-type: none"> 1. Describe what is meant by "operation" 2. Describe what is meant by "maintenance" 3. Explain the importance of operation and maintenance in water supply schemes
4	Operating Water Supply Schemes	<ol style="list-style-type: none"> 1. Describe factors which affect the operation of water supply schemes 2. List activities required in operating water supply schemes 3. Plan for challenges related to the operation of water supply schemes 4. Analyze different operation and maintenance tasks and how to pay for them
5	Maintaining Water Supply Schemes	<ol style="list-style-type: none"> 1. Explain different types of maintenance 2. List activities required for maintenance 3. Create a plan for maintenance activities
6	Achieving O&M Objectives	<ol style="list-style-type: none"> 1. List common objectives for operation and maintenance 2. Prioritize different operation and maintenance objectives 3. Create strategies for achieving priority objectives

Lesson Plan #	Lesson Plan	Learning Outcomes
7	O&M Skills Practical Session	<ol style="list-style-type: none"> 1. Optional: Understand how to use ENPHO field test kit 2. Identify tools and fittings used in maintaining water supply schemes 3. Practice making different types of fittings
8	Sustainability Planning	<ol style="list-style-type: none"> 1. Explain sustainability 2. Describe ways to make water supply schemes more sustainable 3. Conduct an analysis of their water supply scheme 4. Identify priority management areas for improvement
9	Link to WASH	<ol style="list-style-type: none"> 1. Describe the WASH acronym 2. Explain disease transmission routes 3. Explain the link between WASH and water supply schemes
10	Workshop Closing	<ol style="list-style-type: none"> 1. Complete a self-assessment. 2. Evaluate whether learning expectations were met. 3. Complete a final evaluation.
11	Day 1 Review	<ol style="list-style-type: none"> 1. Recall information from the previous day.
12	Day 2 Review	<ol style="list-style-type: none"> 1. Recall information from the previous day.

1.4 Agenda

The general outline of the workshop is as follows:

- **Workshop opening.** To welcome people and allow participants and trainers to get to know one another.
- **Individual sessions.** To focus on a selected topic. Each individual session includes an introduction, a main lesson, and a closing activity to review the content.
- **Breaks and lunch.** To keep people working and feeling positive, breaks are needed. Plan for a mid-morning and mid-afternoon break that allows people to use the washroom, take a drink or eat a snack. While planning your workshop it is also important to clarify with participants in advance as to whether or not food and snacks will be provided.
- **Review of previous day.** Start the day with a review of the material learned during the previous day. This also helps focus the participants and trainers' brains on the workshop. See the list of review tools in Trainer Manual Appendix 2 for activities and review questions you can use.
- **End of day review.** To gain feedback from the participants and to clarify any areas of uncertainty. Example review activities are provided in the Trainer Manual Appendix 2
- **End of day evaluation.** To gain feedback from the participants and to clarify any areas of uncertainty. See the list of evaluation tools in the Trainer Manual Appendix 2 for activities you can use.
- **End of workshop closing.** The end of the workshops can be official or unofficial depending on what is appropriate.
- **End of workshop evaluation.** To allow participants evaluate the whole workshop. Feedback from the participants can be helpful to update the lessons along with the feedback to trainers and host to improve the training events.
- **Organizer and trainer's debrief.** A daily exercise to discuss what went well, what areas of the day can be improved and what needs to be done for the next day and in the future. Debriefs are held at the end of the workshop.

The agenda for this workshop is three days. Depending on circumstances, the trainers may wish to modify elements of the workshop to meet participant needs. The following agenda shows the arrangement and flow of the lessons and each training day.

3-Day – Operation and Maintenance of Water Supply Schemes Schedule











Ideal schedule if participants only have time to cover the operation and maintenance of water supply scheme, making the water supply scheme sustainable and hands on practice of common fittings used while operation and maintenance of water supply scheme.

Time	DAY 1	DAY 2	DAY 3
10:00AM-12:00PM	Workshop Introduction (1 hour) Introduction to Water Supply Schemes (2 hours)	Morning Review (30 minutes) Factors Affecting Operation and Maintenance (2 hour)	Morning Review (15 minutes) Practicing O&M Skills continued (5 hours 30 mins)
15 min	BREAK	BREAK	BREAK
12:00PM – 1:00PM	Introduction to Water Supply Schemes continued	Factors Affecting Operation and Maintenance (Continue)	Practicing O&M Skills continued
1 hour	LUNCH	LUNCH	LUNCH
2:00PM – 4:00PM	Introduction to Operation and Maintenance (1 hour) Operating Water Supply Schemes (2 hours)	Sustainability Planning (1 hour 15 minutes) Link to WASH (45 minutes)	Practicing O&M Skills continued
15 min	BREAK	BREAK	BREAK
4:00PM – 5:00PM	Operating Water Supply Schemes continued Daily closing	Creating Operation and Maintenance Plan (1 hour) Daily closing	Workshop Closing (45 minutes)

Note: In the practical session, one will be leading the session and other trainers will be supporting the lead.

Lesson Plans

Here is a list of the icons used in this Trainer Manual and their explanations.

	Lesson Description. Describes broadly what the lesson will be about.
	Learning Outcomes. Describes what the participants will be able to do by the end of the lesson to demonstrate increased knowledge, improved skills or changes in attitude.
	Time. The clock symbol appears next to the amount of time the lesson may take. This is an estimate and the lesson may be longer or shorter depending on how you facilitate it.
	Materials. Lists all the materials that will be required for the lesson.
	Preparation. The clipboard appears when there is preparation that needs to be done prior to the lesson, including materials needed and things to do in advance.
	Introduction. This hook appears where there is an introduction to a topic. This will help participants connect personal experience to the knowledge they are about to learn.
	Key Points. The key appears where there are important points and topics to discuss. These are reminders of what key points the participants should understand by the end of the lesson.
	Main Activity. The puzzle appears at the beginning of a main learning activity.
	Trainer Notes. The exclamation point appears to remind you of things to do or consider while facilitating the lesson.
	Review. The question mark appears when you are reviewing a topic or checking for learning. What have participants learned? Can they recall the information?
	Handouts. This appears when there are handouts for the participants.

Lesson Plan 1: Workshop Introduction



1 hour

Lesson Description



The focus of the introduction is to create a safe learning environment and provide an overview of the coming three days. During the introduction participants meet each other, discuss how they will work together during the workshop, develop a list of expectations, and learn about the agenda.

Learning Outcomes



At the end of this session, participants will be able to:

1. Describe the agenda for the workshop.
2. Discuss how the group is expected to work together during the workshop.
3. Discuss the group's expectations for the workshop.

Materials



- Flip chart paper
- Tape
- Markers
- Pens (1 per person)
- Notebooks or paper (1 per person)
- Name tags (See end of lesson plan for examples)
- Optional: ENPHO Introduction PowerPoint

Preparation



- Read and prepare the lesson plan
- Write the agenda for the day on flip chart paper
- Write the heading "Group Learning Expectations" on flip chart paper
- Write the heading "Group Agreements" on flip chart paper and points to consider in the topic
- Create a "Self-Assessment table" for the different workshop topics, with a range of "None" to "A little" to "A lot."
- Put a notebook, name tag and pen at each seat (1 per person)
- Prepare name tags
- Optional: Prepare the ENPHO Introduction PowerPoint, computer and projector

Introduction

25 minutes



1. Introduce trainers, workshop hosts and other guests as appropriate.
2. Review objectives of the training.
3. Explain the building/workshop layout, bathroom location, emergency exits, first aid, and daily schedule.

4. Lead an icebreaker activity to help participants meet each other and introduce themselves to the group. See options below for a suggested icebreaker.

Icebreaker and Introductions



1. Choose four “Getting to know you” topics in advance. Possible topics include: where they work, favourite colour, favourite food, hobbies, etc.
2. Give a piece of blank paper to each participant
3. Ask the participants to divide their paper into four equal squares by drawing one vertical line and one horizontal line.
4. Tell participants you want them to draw or describe something about themselves in each of the four squares.
5. Present participants with the four assigned topics to fill in their squares.
6. Give participants a few minutes to fill in their four squares according to the assigned topics.
7. Ask each participant to spend 1-2 minutes to introduce themselves and present their four squares to the large group.
8. Continue until all participants have presented.

Group Expectations

10 minutes



1. Ask the participants to list what they hope to learn or expect during the training. Record people’s expectations on a piece of large paper as they list them.
2. Review the list and identify the expectations that you will be covering during the workshop.
3. If there are things that are outside the scope of the workshop, explain that they will not be discussed. Offer any alternatives for discussing those topics if they are relevant, such as websites, research papers, other workshops, consulting visits and names of other organizations.

Self-Assessment

10 minutes

1. Show participants the self-assessment table you have prepared.
2. Explain that this is a tool to find out what knowledge and skills we have before starting the workshop. Explain that it is OK for participants to have little or no knowledge at the beginning. The goal of the workshop is to help each person learn more on the different topics.
3. Ask participants to place a new mark/sticky dots on the self-assessment chart to indicate their existing knowledge level. Summarize results to the large group.
4. Explain that you will revisit the self-assessment again at the end of the workshop.

Group Agreement

10 minutes



1. Explain that ground rules are agreements created by the group that will allow everyone to learn together.

2. Ask the participants: “Reflect on your past training or learning experiences. What made those experiences positive or negative?”
3. Ask the participants: “What are some ways we can create a positive learning environment for everyone?” Write their ideas on the flip chart paper.
4. Add: *respect, ask questions, silence cell phones, and punctuality* if these terms are not included.

OR,

5. Paste the flip chart paper with group agreement (prepared in advance) and discuss.
6. Explain that any other expectations can be added throughout the workshop.
7. Place the flip chart in a prominent place to be seen throughout the workshop.

Workshop Format and Agenda

5 minutes



1. Discuss your approach to training and learning:
 - Experiential, hands-on and learn by doing
 - Individual and group activities
 - Case studies and learning from others' experience
 - Open discussion, questions and answers
 - Develop a sense of community and network within the group
2. Review daily agenda with break and lunch times.
3. Ask the participants if they have any questions at this point.

Optional: Introduction to Organization

10 minutes



1. Introduce your organization if delivering the workshop to a new client
2. Talk about the following to introduce your organization:
 - a. Organization mission and vision
 - b. Organizational strategies
 - c. History of the organization
 - d. Activities to date
 - e. Services offered
 - f. Future plans

Review

5 minutes



1. Ask if there are any thoughts or questions.

Reflections on Lesson

Lesson Plan 2: Introduction to Water Supply Schemes**2 hour****Lesson Description**

The focus of the lesson is to introduce water supply schemes, types of water supply schemes, and the parts of the scheme. Participants will also explore the steps to form 'Water User Committee' and roles of user committees to operate and maintain water supply schemes sustainably.

Learning Outcomes

By the end of this session, participants will be able to:



1. Describe water supply schemes and types of water supply schemes
2. List the parts of water supply schemes
3. Explain the role of user committees in operation and maintenance of water supply schemes

Materials

- Flip chart paper
- Markers
- Meta cards
- Tape
- Water Supply Scheme handout

Preparation

- Read and prepare the lesson plan
- Write learning outcomes on flip chart paper
- Write the parts of water supply schemes on meta-cards.
- Prepare the water supply scheme drawing
- Prepare a flip chart paper with responsibilities of the water user committees (See notes at end of lesson plan)
- Prepare meta-cards with the following topics: "What is a water supply scheme" "Parts of water supply schemes", "Forming a user committee," and "Responsibilities of user committees."
- Print 1 "Water Supply Scheme" handout for each participant

Introduction**20 minutes**

1. Inform participants that they are going to start the workshop with a group activity. For this, participants will be divided into 3 groups.
2. Explain that in their groups, they will draw a diagram of their existing water supply scheme.

Trainer note: If participants are from different water supply schemes then ask them to refer to any one scheme.

3. Inform them that they will have 10 minutes to draw their map.
4. Divide participants into 3 groups, provide a brown sheet of paper and markers to each, and ask them to start their drawings.
5. As the participants are drawing their diagram, circle the room and check with each group to see how much they know already and are able to draw. If participants struggle too much, you can move on more quickly to the next section.
6. Have each group briefly present their diagrams. Explain you will explore the components in more detail in the next activity.
7. Present the lesson description or learning outcomes.

Water Supply Schemes, Parts and Types of Water Supply Schemes

45

minutes



1. Ask participants: “What do we mean when we talk about a water supply scheme? Why is it beneficial?”
2. Discuss and summarize their answers and describe water supply schemes along with the key benefits. See the trainer’s notes at the end of the lesson plan for key information in more detail.
 - a. Water supply is the provision of water by public utilities, commercial organizations, community endeavors, or by individuals, usually via a system of pumps and pipes.
 - b. Benefits in sustainable health and hygiene benefits to the rural population through improvements in water supply and sanitation, engage in income generating work by saving time to fetch water, etc.
3. After discussion on water supply schemes, ask participants to return to their drawings from the introduction session.
4. Ask the participants to highlight any parts of water supply schemes that they have mentioned on their drawings. As the groups highlight the parts, paste cards with the parts of the water supply scheme, categorizing them into 2 groups: transmission line and distribution line.
5. If not all the parts are mentioned in the picture or during the discussion, ask participants what might be other parts. If they mention any others, add the cards to the board. If participants miss some parts, add them yourself.
6. After listing all the parts, ask participants: “Why there are 2 categories and what does each signify?”
7. Collect participant’s answer and summarize them as follows:
 - a. A transmission line collects water from the source
 - b. Distribution lines carry water to the users in the community
8. Tell the participants you are going to show them a complete picture of a water supply scheme.
9. Show the picture of the complete water supply scheme. If you are able to draw it, you may wish to do so. Ask them to compare it to their diagrams and try to identify any missing parts.

Trainer note: As you show or draw the diagram of water supply scheme, name the parts of the schemes to the participants.

10. After discussing the parts of water supply schemes, referring to the whole drawing of water supply scheme, explain the types of water supply scheme.
 - a. Open system
 - b. Closed system
11. After the discussion, collect the meta-cards (with name of the parts of water supply schemes) from the wall or board and inform participants the next activity will be to explore each of these parts in more detail.
12. Explain that in this discussion, participants will be divided into 4 different groups. In each group, participants will be provided 3 meta-cards with different parts of water supply schemes.
13. In their groups, participants are to:
 - a. Discuss the function or the use of part
 - b. They should write a line or two about each part on the back of each meta card
14. Participants will be given 10 minutes for the activity and after that time, present their descriptions to the full group.
15. Have the groups present their parts of the water supply scheme starting from the intake. As the group present on, display the power-point of water supply scheme component one by one and add or correct any information if needed. Continue until all groups have presented.
16. Explain you will give them a handout with detailed information for each part at the end of the session they can use for review.

Formation of User Committees and their Responsibilities

45 minutes



1. Explain that for the continuous supply of water to users, these parts and lines of the water supply scheme should be well maintained.
2. Explain that to conduct necessary operation and maintenance, people need to be responsible for the management.
3. Ask participants: “Do you know who these people are, and how they are selected for this purpose?”
4. Collect answers from participants and explain that a group of people is often selected from within a community. This group is typically responsible for operating and maintaining water supply schemes effectively.
5. Discuss briefly there are four main steps for the formation of this group. You may also want to write these four steps on flip chart paper or the board and discuss each point in brief.
 - a. Identify the users
 - b. Conduct mass meetings
 - c. Form or reform a water user committee
 - d. Register and renew the water user committee
6. Explain that this group is formed from within users, representing the whole group of users or the community. Because of this, the group is termed a “Water User Committee” or sometimes a “Water Supply and Sanitation User Committee”.
7. Ask the participants: “Once this group has been formed, what do you think are their main responsibilities?”

8. Discuss briefly with the full group and listen to ideas from several participants.
9. Inform participants that they are going to discuss more about this topic in new groups.
10. Explain that for this, participants will be divided into 4 groups and in their groups, they should discuss the responsibilities of the user group. They will have 5 minutes to do this.
11. Divide participants into 4 groups and allow them 5 minutes to discuss.
12. Once all groups have finished, paste the flip chart paper you have prepared with the responsibilities of water user committees at the front and ask the groups to compare their discussed ideas with the list. Refer to the trainer notes for more information.
13. Ask each group if there were any similarities in their descriptions and in the posted list, and if there were any differences. Have each group share 1-2 ideas.

Review
10 minutes

1. Inform participants that they are going to do a review activity.
2. For the activity, participants will be divided into 4 groups and each group will be given one card. On the card will be a specific topic from the lesson.
3. Explain that in their groups, they should discuss the topic and any key information or things they have learned, and then they will give a quick summary to the other groups.
4. Divide participants into 4 groups and provide one of the following cards to each group.
 - What is a water supply scheme
 - Parts of water supply schemes
 - Forming a user committee
 - Responsibilities of user committees
5. Provide 3 minutes time for discussion and after the time ask groups to present a few main points of their discussion in the large group.
6. Distribute the “**Water Supply Schemes**” handout to all participants and tell them that it provides them additional information on each component of the water supply scheme, as well as key considerations for operation and maintenance of that part.



Intake / Catchment	Collection Chamber	Air Valve
Break Pressure Tank	Interruption Chamber	Washout Chamber
River Crossing	Storage Tank / Reservoir Tank Or Masonry Tank	Tap
Pipeline	Distribution Tank	Sectional Valve

Water Supply Schemes

Water Supply

Water supply is the provision of water by public utilities commercial organizations, community endeavors or by individuals, usually via a system of pumps and pipes.

Benefits

Helps with sustainable health and hygiene benefits to the rural population through improvements in water supply and sanitation, engages in income generating work by saving time to fetch water etc.

Types of Water Supply Schemes

- a. Open Systems
 - i. The source provides consistent and ongoing water supply so that it does not require storage or reservoir tanks.
- b. Closed Systems
 - i. The source does not provide sufficient water to meet regular water demands of the community, and requires reservoir tanks to store water for use.

Parts of Water Supply Schemes

1. Intake or catchment

A barrel or structure is constructed to collect water from a spring or a section of a river. This is called the intake or catchment. The construction intake varies according to different sources of water. If an intake is to be made in a river then a barrel is constructed to block the water and the water is collected in a collection chamber through a pipe. A net is kept in the pipe which is in the barrel. This net is called strainer. Instead of a net, a net like structure can be constructed by making a hole in HDP pipe, a perforated pipe. While keeping a net firstly, a layer of big stones is made and above that layer a net is kept. Mainly an intake should be constructed in such a way where the floating water nearby the land is not able to enter, it should be free of animals, and should be isolated or fenced off to prevent contamination.

2. Collection chamber

A collection chamber is constructed to collect water from the intake. There is a valve inside a collection chamber. The size of chamber can be constructed according to the need.

3. Air valve

The main job of this valve is to bring out the air that might be in the water supply pipe. If the movement of air increases then it decreases the movement of water due to which water cannot flow properly. This air valve is always constructed in a high point of the pipeline.

4. Break pressure tank

This is constructed to control the level of water. In short it is also known as BPT. It controls the pipe from breaking due to increasing level of water. It is constructed below a storage tank. It contains a ball valve which controls the level of water.

5. Interruption chamber:

It also controls the level of water like BPT. This is also known as IC and is constructed above the storage tank. There is no ball valve in it.

6. Washout chamber:

It is constructed to take out the sediments from the pipe. This is also known as cleaning out chamber. It is constructed in the lowest point of the pipeline so that the sediment can be removed.

7. River crossing:

This is constructed to cross rivulets, streams, flood affected areas or shallow areas. If the river crossing length is short, a G.I. pipe is used however if the length is long, HDP pipe is used with the help of metal string.

8. Storage tank or reservoir tank:

Storage tanks are used to collect water. This is also known as reservoir tank or water tank. As per the need, the size of storage tank can be large or small and also it is constructed in different styles. Typically, medium sized tanks are used most frequently.

a. Ferro-cement tank

This tank is circle in shape. These tanks are more prevalent in present days. It is simple, fast and cheap to construct. It doesn't require more stones to construct so it can be constructed in the area where there is lack of stones. Also it requires less cement for the construction. An operation tank is constructed to control water. Storage tanks are often constructed by digging a hole in the land so it is safe and water remains cool.

b. Masonry tank:

It is cubicle in shape. It also consists of an operation chamber. It is constructed in those areas where more stones are found.

9. Distribution tank:

This tank is constructed to distribute water equally in two or more than two reservoirs and all the taps. The size of this tank depends upon capacity of reservoir and number of taps.

10. Sectional valve:

This valve is kept when distribution tank requires section so that there is proper distribution of water from both pipelines.

11. Tap:

According to the village a tap is constructed for 10 houses on average. Firstly a tap stand is constructed with cement and stones. A platform is constructed around the tap and drainage for the waste water is also managed. However, yard connection or one house one tap is being promoted as per “Total Sanitation Guideline”.

12. Pipeline:

HDP pipe is used to transport water from spring to tap. To protect HDP pipe from livestock, fire, humans and also to operate it for a longer period of time, the pipeline is dug under around 90 cm down the ground which also keeps the water cool.



Formation of User Committees

- a. Identify the users:
 - b. Conduct mass meetings:
 - c. Form or reform the water user committee:
 - d. Register and renew the water user committee:
-

Responsibilities of User Committees

1. Firstly, to complete the water supply construction
2. To plan for proper operation and maintenance of water supply schemes and implement
3. To solve any issues relating to the operation and maintenance of water supply scheme
4. Collect feedback from the community/ user's group
5. Maintain water quality being provided in the community through the system
6. Regular collection of operation and maintenance funds and manage the salary of any Village Maintenance Workers (VMW)
7. Maintenance of Water Supply and Sanitation Schemes (WSSS) using the Maintenance Fund
8. Record-keeping of all expenses including expenses during operation and maintenance of the WSSS
9. Work to strengthen and enhance the sustainability of the WSSS
10. Provide suggestions to the user's group
11. Protection of the source of water / intake
12. Discussion about operation and maintenance of the WSSS, sub-committee meetings and keeping the minutes of decisions
13. Inform users about the current situation and changes to conditions of the scheme
14. Supervision of and support to maintenance workers
15. Declaration of open defecation free areas
16. Coordination with related sectors

Steps of constructing and implementing a water supply scheme

1. Need Assessment
2. Pre-feasibility study
3. Contract
4. User committee formation and registration
5. Opening bank account
6. Leadership training
7. Action plan (wellbeing ranking, sub group formation, work division, etc.)
8. Fund collection for capital contribution
9. Procurement plan (group formation, market survey, etc.)
10. Rate finalize and quality inspection
11. Construction phase(first phase in tank to RVT, second DT to tap)
12. Store keeping /recording
13. Mid-term evaluation
14. Project completion and handover (financial clearance, public hearing, etc.)

Lesson Plan 3: Introduction to Operation and Maintenance 75 minutes

Lesson Description



In this lesson, participants are introduced to concepts of operation and maintenance and types of operation and maintenance carried out in the water supply schemes. To this, the lesson also discuss the importance of operation and maintenance in managing water supply schemes.

Learning Outcomes



At the end of this session, participants will be able to:

1. Describe what is meant by “operation” and “maintenance”
2. Explain different types of operation and maintenance in water supply schemes
3. Explain the importance of operation and maintenance in water supply schemes

Materials



- Flip chart paper or white board
- Markers or chalk
- Blank cards or a piece of paper cut into 4 sections

Preparation



- Read and prepare the lesson plan
- Write learning outcomes on a piece of flip chart paper
- Prepare definitions for operation and maintenance (See lesson plan)
- Prepare cards or pieces of paper with four reasons why O&M is important (See lesson plan)

Introduction

5 minutes



1. Ask the participants: “How many of you have a mobile phone?”
2. Ask one of the people who has/ use a mobile phone to explain the different actions they do regularly to use it.
 - i. Check on battery level, charge battery, recharge balance, look for network, put on a cover, put on a screen cover
3. Thank the participant, and ask another participant all the things he/she does to keep their mobile clean and working well over time.
 - i. Change battery, change housing of mobile, repairing any issues
4. Explain to participants that just as with mobile phone- these two groups of activities are things that must be done in the correct management of water supply schemes.

5. Present the learning outcomes or lesson description.

Group definition of terms

15 minutes



1. Ask the participants: “In the introduction, which of the two people was doing activities that were operational activities?” – *The first person.*
2. Tell the group that you want to brainstorm an idea of what it means when you talk about “operation” of water supply schemes.
3. Write the word “Operation” on a piece of flip chart paper or on the board.
4. Ask the participants to tell you key words or related ideas they can think of, and write any ideas they provide on the flip chart. *Possible responses include: using or doing something, daily functioning, service delivery, starting and stopping, users, procedures, handling, action, process, pumping water, turning on valves, etc.*
5. Based on their ideas, you may be able to pull different ideas together into an overall idea of what “operation” means. You may or may not complete a full definition now.
6. Ask the participants: “In the introduction, which of the two people was describing activities that were maintenance?” – *The second person.*
7. Tell the group that just as you did with “operation,” you want to brainstorm an idea of what it means when you talk about “maintenance” of water supply schemes.
8. Write the word “Maintenance” on a piece of flip chart paper or on the board.
9. Ask the participants to tell you key words or related ideas they can think of and write any ideas they provide on the flip chart. *Possible responses include: repairs, fixing, prevention, taking care, protecting, break-downs, wear-and-tear, etc.*
10. Based on their ideas, you may be able to pull different ideas together into an overall idea of what “maintenance” means. You may or may not complete a full definition now.
11. Tell the group you are going to present definitions of the two terms, to compare with their brainstorming.
12. Present the following definitions one at a time and discuss with the full group.
 - a. Operation: The actual running of a technology or service. In water supply schemes, it may include providing fuel, starting and handling pumps, control of water collection points, and mechanical or water treatment procedures.
 - b. Maintenance: The activities that keep the technology or service in working condition, including management, cost recovery, repairs, and preventative maintenance to avoid breakdowns.
8. Ask the participants: “Why do we talk about these two activities together?” – *They must be integrated. Operation will not continue if there are problems with maintenance, and maintenance is not useful if the system stops working and users find alternative water sources.*
9. Further clarify operation and maintenance with an example of house, activities carried out such as coloring, cleaning around is operation while maintaining

broken windows/ doors, leaking roof, crumpled walls etc. is termed as maintenance.

Types of O&M

15 minutes

1. Inform participants that operation and maintenance can be broadly divided into 3 types:
 - a. Regular operation and maintenance
 - b. Planned operation and maintenance
 - c. Emergency operation and maintenance
2. Divide participants into 3 groups. Assign each group a type of operation and maintenance and ask participants to discuss on what they understand by particular type of operation and maintenance.
3. Provide 5 minutes time for the discussion. After the time, ask a participant to volunteer the discussion on regular operation and maintenance. Summarize the idea of the group and add more information if needed.
4. Continue the process for planned O&M and emergency operation and maintenance as well.

Importance of O&M

25 minutes



1. Tell the group you want to have a focused discussion on the different benefits of successful operation and maintenance of water supply schemes.
2. Explain that you are going to divide the participants into several groups. Each group will be given a different reason why operation and maintenance is important, and will discuss among themselves why it is. After they discuss within their groups, they will share their ideas and reactions with the large group.



3. Divide participants into 4 groups and give each group one of the following statements:
 - a. Operation and maintenance keep the system functioning properly
 - b. Operation and maintenance are important to sustainability over time
 - c. Operation and maintenance improve quality of life and health standards
 - d. Operation and maintenance help manage the expenses and investments.
4. As the groups discuss, circulate among them and clarify any confusions they may have. They should discuss why the statement is true and how O&M contributes to the underlined section.
5. After 5-10 minutes, ask each group to explain the reason they had for O&M, and share a few of their ideas on why this is true. If a group experiences significant difficulty, add to their ideas to ensure each of the 4 is discussed appropriately.
6. Clarify any mistakes made by the groups, and then any remaining questions.
7. Tell the groups that together, you want to try to create a full answer responding to the question: "Why is O&M of water supply schemes important?"
8. Write the question on flip chart paper or the board.
9. Together as a group, create a complete answer and write it under the question.
Possible response: Operation and maintenance of water supply schemes is important to ensure good management and provide safe water sustainably to communities over time."

10. Explain to participants that often, the importance of O&M in water supply schemes has been overlooked. One of the main reasons services have failed in the past is not due to technical challenges, but due to poor operation and maintenance, planning, cost recovery, and management.
 11. Tell the participants that throughout this workshop they will practice planning and practical skills related to operation and maintenance of water supply schemes, and by the end they should be prepared to respond to a variety of O&M situations.
-

Review**5 minutes**

1. Ask the participants to form pairs and discuss:
 - Something new they learned about operation and maintenance.
 - Which of the 4 reasons why O&M is important do they think is the most important
-

Reflections on Lesson

Operation and maintenance keep the system functioning properly

- Current status of components of WSSS
- Repairs works are done on time
- Proper operating prevents the blockade of pipeline and other infrastructure of WSSS

Operation and maintenance are important to sustainability over time

- Maintained operation
- O&M prevent WSS from damaging
- Regular supply of water
- Improves the life standard of community
- Lessen financial burden

Operation and maintenance improve quality of life and health standards

- Quantity/ access of water improves sanitation condition of the family and community
- Quality of water prevents water borne diseases
- Minimize the time for fetching water so can involve in other income generating activities
- Improved health of the community minimize the expenses hence increasing the life standard

Operation and maintenance help manage the expenses and investments

- Timely repairs prevents maintenance hence minimize expenses
- Saved money from prevention of maintenance can be invested in other areas
- Proper repairmen and operating provides quality and quantity of water hence increasing life standard and health status of the community
- Mitigate expenses on health and disease condition

Regular Maintenance

During the operation of the water supply schemes, there may occur various problems such as breaking of tap, leakage from pipe and its fittings, breaking of pipe, exposure of pipe to the surface etc. Moreover, there may occur breaking and cracking on other structure of the water supply schemes such as manhole, water tank, intake, tap platform. Such problems have seen frequently while operating the water supply schemes. Thus, its parts should be maintained on daily basis. Such types of maintenance is called regular maintenance. It prevents the probable problems that may occurs on schemes. Therefore, there are no defined duration, time or necessity for it. Regular maintenance is continuous process. For the regular maintenance, the responsibility should be provided to a person for supervision and monitoring of the water supply schemes so that it can be maintained before the occurrence of problems as per requirement and the problems can be identify immediately if occurs and reduce added loss on it. Generally, such type of maintenance is low cost and have great contribution on sustainability of the schemes. It would be better if the responsibility is provided to the person who have good knowledge on water supply schemes if possible. Generally, regular maintenance are conducted by responsible person however assistant or technicians are needed in some conditions. The users' committee should manage the operation and maintenance fund for regular maintenance.

Planned maintenance

Even after the regular maintenance the structure like screening of intake, valves fitted in different place, pumps (if there is pumping system), water meter, pipe, etc. of water supply schemes should be regularly maintained and changed accordingly. Pipeline dissemination, increase in the capacity of storage tank and distribution of tap should be done on regular basis to resolve the problem of growing population and their water demand. In this way the activities which capacitate the water supply schemes and prepare plan to maintained the schemes in every 5/7 years or as per requirement is known as planned maintenance. This type of maintenance require huge amount with the involvement of more human resources and technicians. This will make water supply schemes more efficient and time relevant.

Emergency Maintenance

Beside the Regular and Planned maintenance, another maintenance called emergency maintenance is done in water supply schemes. Other activities beyond the control of human and their thought like flood, landslide, earthquake or other natural calamities bring various problems. This types of emergency bring problems in intake, pipeline, tap and platform. So, they should be maintained as soon as possible which come under emergency maintenance. Such types of maintenance is expensive and requires many human resources.

Lesson Plan 4: O&M Water Supply Schemes



75 minutes

Lesson Description



In this lesson, participants learn about operation and maintenance of water supply schemes over time as per the components. As per the components of the water supply schemes, O&M activities to be carried out in each components are also discussed in the lesson plan.

Learning Outcomes

By the end of this session, participants will be able to:



1. Discuss the possible problems that might arise in the components of WSS.
2. Discuss resolutions for the possible problems in the WSS.

Materials



- Meta-cards
- Flip chart paper
- Markers
- Tape

Preparation



- Read and prepare the lesson plan
- Write the session learning outcomes on flip chart paper

Introduction

5 minutes



1. Inform participants as they already know about water supply scheme and operation and maintenance, they are now going to discuss further on operation and maintenance of water supply schemes.
2. Present the learning outcomes of the lesson plan or the lesson description.

Operation and Maintenance of the parts of WSS

60 minutes



1. Ask participants, if they have to categorize the **parts** of water supply schemes, how they can do it.
2. Discuss with the participants and inform them that the parts of WSS can be best categorized as follow and paste the meta cards on the board while discussing more:
 - a. Intake/ catchment
 - b. Chambers- BPT, IC, CC, sedimentation tank, wash-out chamber
 - c. Reservoir tank and Masonry tank
 - d. Pipeline (Distribution and transmission)
 - e. Valves (air valve, sectional valve)

3. Inform participants that now they are going to discuss further on categorizes in groups. For this, participants will be divided into 5 groups and in their groups, participants are to discuss on the possible problem to be faced in each component (categories) of water supply scheme.
4. Also, inform participants that for the activity they will be getting a brown sheet and will have to note their discussion on first half of the sheet, leaving the other half blank.
5. Divide participants into 5 groups and assign each group one of the above category of component of water supply scheme.
6. Provide a brown sheet paper and ask groups to discuss in groups and note down the important points.
7. Provide 10 minutes time for discussion and note down the points.
8. After the time, inform participants, they are going for the station walk. For this, each group will get 2 minutes to review and add on (if necessary) in each station.
9. After all groups are back to their station, ask groups to discuss on ways to resolve thus discussed problems. Provide 10 minutes time for the activity.

Trainer note: Make sure to incorporate all the points from reference, during the station walk.

10. After 10 minutes, again ask groups to go for a station walk, providing 2 minutes in each station for the review and/ or adding on information if needed.
11. After visiting all the stations, ask groups if they have any confusion and discuss if needed.

Review

10 minutes



1. Ask participants to paste their group work on their nearest wall.
2. Ask groups to go through the group work and note a point (that they find most important) from each component of water supply scheme and note it on their notebook.
3. Ask a participant or two to share their point to large group.

Reflections on Lessons

Trainer Notes

Common Types of Maintenance Activities

- Check water source periodically and ensure it is protected
- If a pump is used, perform regular checks and adjustments of fuel, oil, filters, etc.
- Regularly replace engine oil and pump oil, if applicable
- Check all valves, tanks, lines, and pipes for leaks and breaks
- Check stand-posts or tap-stands for leaks and breaks
- In case of high leakage, initiate leakage detection
- Repair all leaks and breaks
- Clean concrete aprons and drainage areas
- Test the water for microbiological contamination
- Measure the water output periodically
- Check stocks of fuel, spare parts, and tools
- Keep records of maintenance activities
- Keep records of repairs
- Keep records of fuel, spare parts, and tools
- Flush pipes periodically
- Rehabilitate parts of the system which have broken or stopped functioning
- Develop schedules for maintenance activities

Lesson Plan 5: Factors Affecting O&M



2 hours

Lesson Description



In this lesson, participants explore the factors that influence the successful operation and maintenance of water supply schemes, issues or activities relating to those specific factors and analyzing prioritized issues to overcome it.

Learning Outcomes



At the end of this session participants will be able to:

1. Describe factors which affect the operation of water supply schemes
2. List issues or activities relating to those factors for the proper operation and maintenance of water supply schemes.
3. Plan for challenges related to the factors for the proper operation of water supply schemes

Materials



- Flip chart paper
- Markers or chalk
- Handout: Factors affecting operation and maintenance of water supply schemes (1 per participant)
- Handout: Operational Challenge tables (1 copy each)
- Handout: Operation and Maintenance Activities (1 per participant)
- Prepare the table of operation and maintenance- components table in brown sheet
- Projector
- PowerPoint: Keeping the water flowing – Financing water supply schemes

Preparation



- Read and prepare the lesson plan
- Review Part 1: Operating water supply schemes
- Review Part 2: Financing water supply schemes
- Print all required handouts
- Prepare PowerPoint and projector

Introduction

5 minutes



1. Before starting the session, act as if checking your mobile.
2. Explain how your mobile is not working properly over time.

3. Ask participants what might be the factors for your mobile not operating smoothly. Possible answer: Age and condition of the phone, how do you use it-charging time, playing games, dropping it, numbers of applications and storage space, etc.
 4. Explain to participants, similar to using mobile, operating water supply schemes also depends upon various factors and in the session participants will be discussing more on the factors affecting operation and maintenance of water supply schemes.
 5. Present the learning outcomes or lesson description.
- OR,**
6. Inform participants that many water supply schemes are being built and overtime many more are being discarded or are in no working condition.
 7. Ask participants if they can think of any reason for the failure of water supply schemes.
 8. Collect few ideas from participants and present the picture in power-point presentation and ask participants if the reason that participants present is same for the pictures as well.
 9. LINK: Explain participants that they are now going for the discussion on various factors affecting O&M of water supply schemes and present the learning outcomes or lesson description.

Factors which Influence Operation and Maintenance

45 minutes



1. Explain to the participants, as that of operating mobile, operating water supply schemes too is depended upon various factors which can be broadly categorized into 4 main topics.
2. Or, simply relating to pictures from the introduction session, present the main 4 factors affecting operation and maintenance of water supply schemes, written on meta-cards to the participants while discussing briefly on each of the factors.
 - a. Technical factors: pipe size and pressure on pipe
 - b. Managerial factors: proper planning, implementation, monitoring
 - c. Financial factors: At times, the user committee or the community itself determine the low cost as tariff (without calculating operation and maintenance cost). This particular things often leads to low fund for operation and maintenance which leads to failure of the WSS.
 - d. Social factors: community ownership, ability and willingness to pay
3. Share information with the participants about each of these types of factors. Explain that while often people focus on technical factors, inability to properly plan for and manage the other factors has been the main reason behind the failure of many water supply schemes.
4. Tell the participants that in the next activity, they will analyze different ways of avoiding, or mitigating challenges related to these operational and maintenance factors. By thinking about these now, they will be better prepared to manage the O&M of water supply schemes effectively.
5. Explain to participants that now they are going to discuss more on the factors. For this, participants will be divided into 4 groups, each group will be assigned a factor among 4 factors. In their respective group, participants are to discuss further on the factor and write down the issues faced on each factors.

6. Give 5 to 7 minutes for the activity. After the time, ask participants to present their group discussion. As a group present, ask other groups to add on more information and add more if needed.
7. During the presentation of each group, ask participants to prioritize any 2 to 3 issues from the list and continue same with all the groups.

Trainer note: During the presentation of technical factors, make sure the low tariff collection is mentioned as an issues. For this, if needed, add on more information with an example.

Overcoming the Issues for Operation and Maintenance

60 minutes



1. Once all groups are done with the presentation, inform participants that they are now going for detail discussion on the prioritized issues.
2. Provide 3 formats to each group and ask groups to discuss in detail on the related issues and note down the main point as noted in the format.
3. Inform participants that they have 15 minutes for the activity and ask if they have any confusion on the format and start the activity at once.
4. After the time, inform participants that they are going to share their discussion. For this, each group will get a paper from other group and they are to review and discuss on each point.
5. Also inform participants that they will get 5 to 7 minutes time for reviewing each group activity and the groups are to note any points to discuss on their notebook for further discussion.
6. Once all groups have reviewed other groups work, ask participants to discuss the points they have noted starting from issues related to technical factor following other factors.

Review

10 minutes



1. If participants are from different water supply schemes ask participants to form group as per their respective schemes. In their group, ask participants to discuss 4 main factors affecting operation and maintenance of water supply schemes.

Or, if participants belong to a single water supply scheme or are from individual water supply schemes, ask to form small groups of 3 participants and discuss 4 main factors affecting operation and maintenance of water supply schemes.

2. Also in their groups, ask participants to discuss which one of the factors is the main issue in their respective water supply schemes and why.

Reflection on Lesson

Factors affecting operation and maintenance of water supply schemes

Technical

- Quality of the equipment
- Requirement for water treatment
- Use of chemicals
- Complexity of technologies and O&M activities
- Availability and cost of spare parts
- Water demand and number of users

Managerial

- Ability to plan for operation and maintenance
- Ongoing and regular monitoring
- Availability of technical assistance
- Ability to communicate with community
- Human resources and staffing
- Leadership

Financial

- Ongoing cost of running the system
- Budget for operation and maintenance activities
- Tariff structure
- Transparency

Social

- Community ownership
- Gender-balanced development
- Understanding of benefits
- Habit to use the system
- Demand for service and improvements
- Ability and willingness to pay
- Maintenance culture within community

Adapted from: BRIKKÉ, F. (2000): Operation and Maintenance of rural water supply and sanitation systems. A training package for managers and planners. Malta: IRC International Water and Sanitation Centre and World Health Organisation. URL [\[http://www.bvsde.paho.org/bvsacq/i/fulltext/rural/rural.pdf\]](http://www.bvsde.paho.org/bvsacq/i/fulltext/rural/rural.pdf)

Financial Factor

- Community members say they cannot afford the tariffs, so they refuse to pay for service.

Social Factor

- The community believes that the organization that built the water supply scheme should be responsible for it, so they neglect to carry out tasks and monitor it.

- Women were not considered in the decision-making during planning and construction of the water supply scheme. It is not convenient for them to use, so they fetch water from other sources.
- People do not know the link between safe drinking water and health, so they are not interested in using the system.

Technical Factor

- The parts for the system are expensive and cannot be purchased nearby.

Managerial Factor

- No one in the community or user committee knows how to test for water quality or repair broken parts.

Example of tariff collection and financial factor

A water supply system in a village has 50 households as beneficiaries. The 'water supply user committee' thought of providing the facilities with minimum rate and thought to charge Rs. 100 only, to each household. However, the cost for operating the system was Rs. 4,500 only (including the chemicals and salary of a care-taker) and the user committee was happy to save Rs. 500 every month.

At the time of monsoon, they had to mend the pipeline washed away by monsoon rain. As the user committee calculate the rate for repairing, the cost exceeded than their saving.

- a. How could the user committee have managed the issue?

Case Study: Financing Operation and Maintenance

A village needs to find out how much it costs to operate and maintain their water supply system so they can manage their finances sustainably. The information below will help you calculate their annual costs.

The village has 150 people.

Number	Material / Human Resources	Cost
6	Meters of pipe each year	Rs 63.00 per meter of pipe
3	Elbow joints	Rs 27.00 per joint
2	Couplers	Rs 52.00 per coupler
3	Pipe clips	Rs 34.00 per pipe clip
4	Valves	Rs 112.00 per valve
1	PVC adhesive solution	Rs 305.00
1	Cement for repairs	Rs 5,000
1	Water quality testing kit	Rs 15,000
2	Community training	Rs 15,000 per training
150	Chlorine – 20L per person per day x 365 Days	Rs 0.0085/L
1	Skilled laborer / technician x 1 day per month	Rs 1500 per day
1	Support staff salary x 12 months	Rs 8,000 per month
1	Miscellaneous costs x 12 months	Rs 500 per month

Costs: What are their total annual operation and maintenance costs?



Revenue: How much should they charge each person to cover the costs + reserve fund?



Operational Challenge Table

Financial Factor	
.....	
Why is this a problem for operation?	
How could this problem be avoided?	
What could be done to respond to this problem?	

Operational Challenge Table

Financial Factor

<p>.....</p> <p>.....</p>	
<p>Why is this a problem for operation?</p>	
<p>How could this problem be avoided?</p>	
<p>What could be done to respond to this problem?</p>	

Operational Challenge Table

<p>Social Factor</p> <p>.....</p> <p>.....</p>	
<p>Why is this a problem for operation?</p>	

<p>How could this problem be avoided?</p>	
<p>What could be done to respond to this problem?</p>	

Operational Challenge Table

<p style="text-align: center;">Social Factor</p> <p>.....</p> <p>.....</p>	
<p>Why is this a problem for operation?</p>	

How could this problem be avoided?	
What could be done to respond to this problem?	

Operational Challenge Table

<p>Technical Factor</p> <p>.....</p> <p>.....</p>	
Why is this a problem for operation?	

<p>How could this problem be avoided?</p>	
<p>What could be done to respond to this problem?</p>	

Operational Challenge Table

<p>Technical Factor</p> <p>.....</p> <p>.....</p>	
<p>Why is this a problem for operation?</p>	
<p>How could this problem be avoided?</p>	

<p>What could be done to respond to this problem?</p>	

Operational Challenge Table

<p>Managerial Factor</p> <p>.....</p> <p>.....</p>	
<p>Why is this a problem for operation?</p>	
<p>How could this problem be avoided?</p>	

<p>What could be done to respond to this problem?</p>	
---	--

Operational Challenge Table

Managerial Factor	
<p>Why is this a problem for operation?</p>	
<p>How could this problem be avoided?</p>	
<p>What could be done to respond to this problem?</p>	

Lesson Plan 6: Sustainability Planning



hour 15 minutes

Lesson Description



In this lesson, participants will use the skills and knowledge they have gained throughout the workshop to examine issues of sustainability and conduct an analysis of their current management of the water supply scheme. They will identify strengths and areas to improve, and highlight priority areas for improvement.

Learning Outcomes



At the end of this session, participants will be able to:

1. Explain sustainability
2. Describe ways to make water supply schemes more sustainable
3. Conduct a strengths and weakness analysis of their water supply scheme
4. Identify priority management areas for improvement

Materials



- Flip chart paper
- Markers or chalk
- Tape
- Projector
- PowerPoint: Keeping the water flowing – Sustainability of water supply schemes
- Sustainability Assessment handouts (1 of each copy; See end of lesson plan)

Preparation



- Read and prepare the lesson plan
- Prepare 3-4 blank pieces of flip chart paper and markers
- Prepare PowerPoint
- Print 1 copy of each Sustainability Assessment handout

Introduction

5 minutes



1. Ask the participants to close their eyes for a moment and relax.
2. Ask them to imagine in their mind the water supply scheme in the future. What does it look like? How is it being managed? What are the characteristics of it? Ask them to try to envision it in their mind.
3. Ask for 2-3 participants to share their ideas. How did they envision the future water supply scheme?

4. Present the learning outcomes or lesson description

What is Sustainability?

15 minutes



1. Ask the participants: “What do we mean when we say something is sustainable?”
 - a. *Sustainability means it functions, it is being used, it continues over time, its costs are covered, and it does not affect the environment negatively.*

2. As participants volunteer ideas, write their responses on the flip chart or board. Summarize their responses and discuss the key features of sustainability.



3. Display the PowerPoint: Keeping the water flowing – Planning for sustainability of water supply schemes (**Slides 1-2**). Discuss characteristics of sustainability.

4. **Show Slide 3** and describe the graph. It shows the stages of planning for water supply schemes. Highlight the 3 main sections – planning and design, construction, and O&M.

5. Ask the participants: “In an ideal situation, when should people start thinking about sustainability?” – *They should be thinking about sustainability in the planning and design phases. This is ideal so important considerations can be factored into the design and construction.*

6. Point out the arrows in the third O&M stage of the graph. #1-2 represent successful sustainability, with the scheme continuing over time. #3 represents a failure of sustainability, with the scheme’s level of benefits beginning to decline over time.

7. Explain that, in the context of operation and maintenance, the lessons and practice sessions from this workshop will contribute to sustainability. The factors they have explored, and the problem-solving and management skills they have practiced, will all contribute to sustainable operation and maintenance.



8. **Show Slide 4.** Explain to participants that thinking about sustainability is not a separate activity from operation and maintenance. **It must be considered as part of ongoing operation and maintenance to be effective.**

9. **Show Slide 5.** Ask the participants: “Because sustainability is part of effective operation and maintenance, what factors do you think will affect it?” Remind them of the factors they have previously covered.

10. Explain to participants the four factors which affect operation and maintenance are the same factors that will affect sustainability. Proper planning for, and management of these factors will increase the sustainability of the system. This must be done at all times.

11. Highlight the fifth factor which has been added – environment factors. Explain that this is because the quality of the water source, how much treatment it requires, as well as its quantity and consistency are all important for sustainability. The environment may also change – soil erosion, landslides, drought, monsoon, etc. and must be considered and planned for.

Sustainability Assessment**50 minutes**

1. Tell the group that you are going to ask them to complete an activity which brings together many of the different skills and knowledge they have practiced throughout this workshop.
2. Explain that you are going to have them complete a sample sustainability assessment of their existing water supply scheme. If they do not currently have a water supply scheme, they should assess their perceived existing level of capacity to manage these aspects.
3. **Show Slide 6.** Explain that you will divide participants into five groups. Each group will be given one of the main areas required for sustainable operation and maintenance.
4. Explain that you will give each group a handout. The handout will have several areas they should analyze. By completing the form they will be able to identify their current areas of strength and weakness in managing this topic.
5. Explain that the form has a checklist and a section to help them think about their scheme.
6. **Show Slide 7.** Tell the participants you want them to think about everything they have learned in the workshop, and to think about the strengths and weaknesses of their current approach.



7. Divide participants into 5 groups and give each group one of the handouts. (See end of lesson plan). Ask them to fill out the form, and using a piece of flip chart paper, create a large diagram or table they will use to present to the other groups.
8. Give each group flip chart paper and markers.
9. After 10 minutes, have each group present. Discuss their analysis with the full group.
10. Continue until all groups have presented.

Review**5 minutes**

In their groups, ask the participants to:

- Identify 1-2 priority areas for them to focus on to work towards sustainable O&M.
- Discuss actions they can take to progress in these priority areas.

Reflections on Lesson

Sustainability Assessment – Environment

Key questions:

- Is the water source protected? Do you check it regularly?
- Do you test the water quality at source and at access points?
- Is there risk for landslide or falling rocks to damage the system?
- Do people in the community use latrines?
- Is solid waste in the community managed?

Strength and Weakness Analysis:

1. Analysis of the current situation

What are the strengths in terms of operation and maintenance? (See key questions)	What are the weaknesses in terms of operation and maintenance? (See key questions)
--	---

Sustainability Assessment – Social Aspects

Key questions:

- Are women involved in design, operation and maintenance conversations, and planning?
- Does the community have a sense of ownership over the water supply scheme?
- Are users of the water supply scheme satisfied with the service and water quality?
- Do people in the community understand the link between water and health?
- Is the system convenient for community members to use?

Strength and Weakness Analysis:

1. Analysis of the current situation

<p>What are the strengths in terms of operation and maintenance? (See key questions)</p>	<p>What are the weaknesses in terms of operation and maintenance? (See key questions)</p>
---	--

Sustainability Assessment – Technical Areas

Key questions:

- Is the water supply scheme simple or complex to operate?
- Are spare parts available and stockpiled?
- Have technicians and staff been properly trained?
- Are chemicals available for water treatment, if required?
- Do you conduct preventative maintenance regularly?

Strength and Weakness Analysis:

1. Analysis of the current situation

<p>What are the strengths in terms of operation and maintenance? (See key questions)</p>	<p>What are the weaknesses in terms of operation and maintenance? (See key questions)</p>
---	--

Sustainability Assessment – Management

Key questions:

- Do you regularly monitor the system?

- Is technical assistance available, if required?
- Do you communicate regularly with the community and respond to user concerns?
- Do you have a clear committee structure with functioning roles?
- Do you hold regular meetings to discuss planning, finances, and operation and maintenance?

Strength and Weakness Analysis:

1. Analysis of the current situation

<p>What are the strengths in terms of operation and maintenance? (See key questions)</p>	<p>What are the weaknesses in terms of operation and maintenance? (See key questions)</p>
---	--

Sustainability Assessment – Finances

Key questions:

- Are users willing and able to pay?
- Do you have a reserve operation and maintenance fund?
- Have you calculated operation and maintenance costs and planned to cover expenses?
- Do you have clear and transparent financial management systems?

Do you have a tariff, and what costs does the tariff cover?

Strength and Weakness Analysis:

1. Analysis of the current situation

What are the strengths in terms of operation and maintenance? (See key questions)	What are the weaknesses in terms of operation and maintenance? (See key questions)
--	---

Keeping the water flowing:
 Planning for the sustainability of water supply schemes

image source: <http://www.water-supply.org.uk/Files/Attachments/Day%209%20-%20Schemes.pdf>

What does it mean to be sustainable?

- The service is being used over time
- The service functions well
- It delivers an acceptable level of quality
- It is well-managed
- Its operation, maintenance, and replacement costs are covered
- It does not affect the environment negatively

image source: <http://www.water-supply.org.uk/Files/Attachments/Day%209%20-%20Schemes.pdf>

When does sustainability begin?

Source: BRUXÉ, F. (2000). Operation and Maintenance of rural water supply and sanitation systems. A training package for managers and planners. Veolia ITC

Factors influencing sustainability

Effective operation and maintenance is directly tied to sustainability of the water supply scheme. All O&M activities need to be well-managed to achieve sustainability.

Sustainability planning and activities **are not secondary activities and cannot be separated from effective O&M**. They are the same.

Source: BRUXÉ, F. (2000). Operation and Maintenance of rural water supply and sanitation systems. A training package for managers and planners. Veolia ITC

Factors influencing sustainability

1. Technical factors
2. Financial factors
3. Social factors
4. Managerial factors
5. Environment factors

Source: BRUXÉ, F. (2000). Operation and Maintenance of rural water supply and sanitation systems. A training package for managers and planners. Veolia ITC

Sustainability Assessment

Assess capacity in these five areas to highlight strengths, weaknesses, and plan for improvement

- Environmental factors
- Social factors
- Technical factors
- Financial factors
- Managerial factors

image source: <http://www.water-supply.org.uk/Files/Attachments/Day%209%20-%20Schemes.pdf>

Strengths and Weaknesses

Strengths
Weaknesses

image source: <http://www.water-supply.org.uk/Files/Attachments/Day%209%20-%20Schemes.pdf>

Lesson Plan 7: Link to WASH



45 minutes

Lesson Description



The lesson plan focuses on the importance of WASH for community health, its link to the water supply scheme, and the role of the water supply user committee in advocating for better WASH practices. Participants will also understand disease transmission routes and the link between WASH practices.

Learning Outcomes

By the end of this session, participants will be able to:



1. Describe the WASH acronym
2. Explain the link between improved WASH and water supply schemes
3. Explain disease transmission routes

Materials



- Flip chart paper
- Markers
- 5F-diagram cards
- 5F diagram flex / poster

Preparation



- Read and prepare the lesson plan materials
- Write the session learning outcomes on flip chart paper
- Prepare the 5F diagram game cards

Introduction

5 minutes



1. Ask the participants: “When we talk about water supply user committees, what other word is often linked in this description?” – *Sanitation*.
2. Collect responses from participants and if they do not have the correct answer, tell them the term is “sanitation.” In many cases, the water supply user committee is termed as the “Water and sanitation user committee.”
3. Ask participants:
 - a. “Why do you think this term is linked to the water supply committee?”
 - b. How are these two things connected?”
4. Again collect the answers from participants and inform them that they are going to explore further on how these words connect to each other.
5. Present the learning outcomes of the session.

Water, Sanitation and Hygiene

15 minutes

1. Ask participants: “What are your thoughts on connecting words like “sanitation” or “hygiene” to the water supply user committee?”
2. Give them a minute to think on the topic and collect their ideas.
3. Summarize all the answers from the participants that there is significant link between these and water. – *Safe water, sanitation and hygiene as one are incomplete without the other. In absence of one, there is a huge impact on human health. So, these three are termed together as WASH - Water, Sanitation and Hygiene*
4. Write the term WASH on the flip chart or board and make it clear it is composed of these three terms.
5. Ask the participants: “How does correct operation and maintenance of the water supply scheme help protect health?” – *It provides safe and sustainable drinking and washing water to the community, an important component of health.*
6. Ask the participants: “By itself, is it enough to keep the community healthy?” – *No.*
7. Use the following example to help participants make this connection:
 - a. In absence of sanitation, supplied water might not be safe, the source can easily become polluted, and in absence of hygiene, even the supplied safe water might be re-contaminated by human behaviors.

Disease Transmission Routes and Barriers

20 minutes



1. Inform participants that they are further going to do an activity to demonstrate how these different behaviors can contaminate water, spread disease, and affect community health.
2. Explain that for this activity, participants will be divided into 5 groups and each group will be given a set of cards which the groups have to arrange into sequential order.
3. For the activity, they will get about 5 minutes time.
4. Divide into 5 groups and provide the cards of 5F diagram and ask them to start the activity.
5. After 5 minutes, tell participants that the cards give idea on the route of disease transmission.
6. Presenting the 5F diagram flex, summarize the idea and ask each group to name their routes.
7. As the groups name the route, discuss the barrier to the route.

Review

5 minutes



1. Inform participants that they are going for a review activity.
2. For the activity, participants will be divided into pairs ask them to discuss:
 - What is WASH?
 - Why is WASH important for the water user committee to address?
 - What are some things they could work on to improve WASH in the community?

Reflections on Lessons

Following are examples of barriers for the transmission routes:

- **Barriers for Flies:**
 - Cover your food and water
 - Keep your dishes clean and covered.
 - Use a toilet to prevent flies from coming in contact with feces
 - Dispose of solid waste properly so it does not attract flies
 - Use screens/ nets on doors and windows of houses

- **Barriers for Fingers:**
 - Hand-washing at critical times with soap. The critical times are 3 “afters” and 3 “befores.” Washing hands properly with soap at these critical times can reduce incidences of diarrhea by up to 45%.
 - I. After using toilet
 - II. After cleaning child feces
 - III. After touching waste
 - IV. Before eating
 - V. Before feeding
 - VI. Before preparing food

- **Barriers for Fluids (Water):**
 - Use of toilet to prevent source contamination
 - Source water protection
 - Using any Point-of-use water treatment option
 - Safe storage

- **Barriers for Fields:**
 - Use of toilet or latrine
 - Wash raw fruits and vegetables with safe water
 - Cook vegetables thoroughly

- **Barriers for fowls (Animals):**
 - Use of toilet to block animals from contacting feces
 - Keep animals contained (for example, on tethers or in kennels)
 - Keep food in places where animals cannot access it

Additional, latrine construction and use also contributes highly as a barrier to contaminate food and water.

Lesson Plan 8: Creating O&M Plan**Lesson Description**

In this lesson, participants create operation and maintenance plan for sustaining water supply schemes, clarifying what activities are to be carried out along with the frequency, materials needed for implementing activities, estimated expenditure and person responsible for implementing the activity.

Learning Outcomes

At the end of this session participants will be able to:

1. Create operation and maintenance plan for their respective water supply schemes.

Materials

- Flip chart paper
- Markers or chalk
- Format for creating O&M plan

Preparation

- Read and prepare the lesson plan
- Print all required handouts- table for creating plan and table of ideal scenario

Introduction**10 minutes**

1. Without prior information or any kind of preparation, ask participants to draw a picture of their choice in their notebook and for the drawing, they have 15 seconds only.
2. Inform participants that their time start at the moment. After 15 seconds, ask participants to show their drawing. *Possibly, participants will not have a complete drawing as they were not prepared for the activity.*
3. Ask participants, why they could not finish a drawing or they do not have a definite kind of drawing. *Possible answer: Participants were not prepared and they did not get any time for planning.*
4. Inform participants that they are again going for drawing, but this time they can think and plan for the drawing that they wish to draw in 15 seconds.
5. Provide few seconds times to think, plan and prepare for the drawing.
6. After the time, ask participants to draw picture and ask them to stop after 15 seconds.
7. Ask to participants what the difference between first and second drawing is.
8. Ask a participant or two to share their thoughts and link that with proper planning and preparation, we are better able to do our work more efficiently. Similarly, in water supply schemes also we need to plan and prepare for the possible activity and the lesson plan deals with creating plan for operation and maintenance of water supply schemes.
9. Present the learning outcomes or lesson description.

Creating Plan

45 minutes



1. Ask participants while discussing on creating plan for operation and maintenance of water supply schemes, what are the things to be considered.
2. List down participants responses on flip chart paper.
3. Discuss further that the main things to consider are the time of visit, who is responsible, materials required and etc.



4. Provide the format of creating plan to each individual and ask participants to go through the format.
 5. Inform participants that they are now going for the group work. Participants will be divided into 5 groups and in their particular group, participants are to discuss and fill up the form.
 6. Inform participants will get 10 to 15 minutes for the activity. Divide participants into groups and ask groups to start the group work at once.
 7. After the time, ask participants to present their group work one after another and after all groups have finished, summarize the points and discuss further if needed.
-

Review

5 minutes



1. Ask participants, looking at the table thus discussed, which activity/ties is more frequent.
2. Ask a person or two to volunteer their responses.
3. Again, ask participants who is the main responsible person for the operation and maintenance activity of water supply schemes.
4. Ask a participant or two to volunteer their responses and discuss further if needed

Practicing Operation and Maintenance Skills

WSS parts/ Activities	Frequency	Materials/ resources needed		Activity Cost	Responsible Person
		Materials	Quantity		
Intake/ catchment:					
Chambers					
Reservoir					
Pipeline					
Valves					

tflnsf – s-!_ M OG6]s / sn]S;g RofDa/sf] ;+rfng / ;Def/ tflnsf

qm;+=	lqmofsnfk	af/Daf/tf
!	OG6]s / sn]S;g RofDa/sf] ;du lg/Llf0f	;fKtflxs
@	jf;cfp6 eNe vf]n]/ sn]S;g RofDa/ ;kmf ug]{	;fKtflxs
#	kfOknfOgdf ePsf Pc/ eNe, jf;cfp6 eNesf] vf]n]/ ;kmf ug]{	q}df]s

tflnsf – s-@_ M k|zf/0f nfOgsf] ;+rfng / ;Def/ tflnsf

qm;+=	lqmofsnfk	af/Daf/tf
!	kfOk km'6]sf], b]lvPsf] cflbaf/] lg/Llf0f	;fKtflxs
@	kfOksf] hf]gL{, eNe cflbaf6 r'xfjt ePsf]	;fKtflxs
#	kfOknfOg lg/Llf0f;DaGwL k ltj]bg k z ug]{	;fKtflxs

tflnsf – s-#_ M :nf] :of08 lkmN6/sf] ;+rfng / ;Def/ tflnsf

qm;+=	lqmofsnfk	:yfg	af/Daf/tf
!	wldnf]kgf, /+u	k j]z ePsf] kfgL / lgl:sPsf] kfgL	b}lgs
@	lkmN6/ ;kmf ug]{		cfjZostf cg';f/
#	lkmN6/ dfWodsf] cj:yfaf/] hfFr	lkmN6/ PsfO	df]s
	<ul style="list-style-type: none"> dfWodsf] df]6fO 		
	<ul style="list-style-type: none"> dfWodsf] ;txdf cgfjZos j:t' hDdf ePsf] 		
\$;+/rgfsf] ef}lts cj:yfsf] lg/Llf0f	s'g} klg :yfgdf	b}lgs

Practicing Operation and Maintenance Skills

%	jf;cfp6 eNe, cf]e/km\nf] eNe cflbsf] cj:yf		;fKtflxs
---	---	--	----------



tflnsf – s-\$_ M :6f/]h 6}+ssf] ;+rfng / ;Def/ tflnsf

qm;+=	lqmofsnfk	:yfg	af/Daf/tf
!	eNen] rnfpv v's'nf] 5÷5}g jf eNen] 7Ls sfo{ ul//x]sf] 5÷5}g	eNe	;fKtflxs
#	kfgLsf] r'xfjt	kfOk, eNe	b}lgs
%	kfOk, eNedf lvof nfu]sf]		df];s
^	k];/ kDkx?sf] k/LIfOf		;fKtflxs
&	:6f/]h 6}+sdf e]IG6n]zg kof{Kt 5÷5}g, e]IG6n]zgd /flvPsf] hfnLsf] cj:yf 7Ls 5÷5}g	:6f/]h 6}+s, cf]e/x]8 6}+s	b}lgs
*	6}+s ;kmf ug]{	:6f/]h 6}+s, cf]e/x]8 6}+s	jflif{s
(;+/rgfdf lr/f, r'xfjt	:6f/]h 6}+s, cf]e/x]8 6}+s	jflif{s

Tflnsf – s-%_ M ljt/Of k|0ffnLsf] ;+rfng / ;Def/ tflnsf

qm;+=	lqmofsnfk	:yfg	af/Daf/tf
!	eNen] rnfpv v's'nf] 5÷5}g jf eNen] 7Ls sfo{ ul//x]sf] 5÷5}g	eNe	;fKtflxs
@	kfOknfOg, eNe, hf]gL{, wf/f ljt/Of u/]sf] :yfgaf6 r'xfjt	kfOknfOg), eNe RofDa/	b}lgs
#	ljt/Of kfOknfOgdf 9n tyf cGo dfWodaf6 kfgL k b'ifOf x'g] ;Defjgf	kfOknfOg, RofDa/	df];s
\$	kfOk, lkml6 ^a u; h:tf cfjZos ;fdu L tyf pks/Ofx? pknJw 5÷5}g	:6f]/, ahf/	df];s
%	wf/f ljt/Of ;+Vof		df];s
^	lau]sf] / cglws[t ld6/		cfjZostf cg';/f
&	kfgLsf] axfj / rfksf] lg/LIfOf	wf/f	;fKtflxs
!)	cglws[t h8fg		df];s

!!	;du k 0ffnLsf lj:tf/ / ljsf;sf] k'g{d'Nof+sg		jflif{s
----	--	--	---------

Lesson Plan 9: Practicing Operation and Maintenance Skills 30 min

Lesson Description



This lesson focuses on the introduction of tools and fittings for operation and maintenance activities of water supply schemes. It allows participants hands-on practice to make or adapt locally available HDP fittings and thread cutting of GI pipe.

Learning Outcomes



At the end of this session participants will be able to:

1. Identify tools and fittings used in maintaining water supply schemes
2. Practice making different types of fittings
3. Understand how to use ENPHO field test kit

Materials



- Flip chart paper
- Tape
- Markers
- Meta cards
- Tools for O&M of the water supply scheme
- Fittings used in the water supply scheme
- ENPHO Test Kit or PowerPoint

Preparation



- Read and the prepare lesson plan
- Write learning outcomes on flip chart paper
- Collect the tools and fittings for operation and maintenance of water supply scheme based on what is locally available or used in the existing scheme
- Cut the tools name for cut cards
- Cut and prepare 4 sets of fittings cut card, each consisting a set of 4 pictures of fittings, 4 cut cards with name of the fitting, 4 cut cards with functions of the fittings and 4 cut cards with 'where does the fittings fit in WSS'.
- Prepare 5 stations for practicing to make the fittings along with the necessary materials and instructions for making the fitting
 - Elbow joints
 - T joints
 - Y joints
 - Reducers

Practicing Operation and Maintenance Skills

- Thread cutting
- Prepare a separate corner with a blow torch and heating plate
- Prepare PPT about ENPHO Test Kit (if there is not available Test Kit).

Introduction

5 minutes



1. Ask participants to share their most memorable experience of maintaining or repairing anything broken. (two to three maximum)
2. Again ask the same participants, "What tools did you use?"
3. Summarize participant responses and explain similarly, if participants need to maintain their water supply scheme they will need to collect materials, fittings and tools in addition to the planning and management activities they have previously explored. For maintenance to be effective, it is essential to develop some specific skills, set a schedule, and follow correct techniques.
4. Present the learning outcomes or lesson description.

OR

5. Ask participants: "If you wanted to make anything new, what would you need?"
 - *Possible answer: required materials and/or tools*
6. Inform participants that in a similar way, if participants need to maintain their water supply scheme they will need to collect materials, fittings and tools in addition to the planning and management activities they have previously explored. For maintenance to be effective, it is essential to develop some specific skills, set a schedule, and follow correct techniques
7. Present the learning outcomes or lesson description.

Tools for Operation and Maintenance

30 minutes



1. Linking to the introduction, inform participants that they are going for the tools that they might need for O&M of WSS.
2. For this activity, each participant will get a cut card with the name of a tool on one side and a sign on other side (or letter of the alphabet - one letter spread across two cut cards to form a pair) which will help participants to form a pair. (See end of lesson plan).
3. In their pairs, participants will have to discuss the function of tools that they got on their cut cards and also find the tool from the toolbox.
4. Inform participants that they have 3 minutes to discuss, and after 3 minutes they will have to present it to the large group.
5. Provide a cut card to each participant and ask them to form pairs, find the tools and discuss the function of the tools.
6. After the discussion in pair, ask each pair to present their discussion along with the tool.

Trainer note: Make sure to add missing information or correct any if necessary.

Fittings used in water supply schemes

40 minutes



1. Inform participants that they are going to discuss further about the types of fittings used in water supply schemes. For the activity, participants will be divided into 4 groups and in each group, 4 different envelopes will be provided with numbers 1, 2, 3 and 4 in each envelop.
2. Firstly, the groups are to match the cut cards from envelop 1 and 2, for which the groups will get 4 minutes time to discuss and match.
3. After all groups are done matching, ask groups to go for a station walk. For the station walk, groups will get a minute in each station to review the group work.
4. After the station walk, groups are to go for envelop 3 and match it to their earlier work. Again, after the matching, each group will go for the station walk.
5. Again, after station walk, groups are to go for the envelop 4 and match it. Similar to the earlier step, after matching ask groups to review the activity of groups through station walk. This time, groups will get 2 to 3 minutes for reviewing and discussing the work.
6. Divide participants into 4 groups and provide a set of envelop to each group and ask them to start to match the cut cards.
7. Discuss and clarify if needed.

Hands-on practice at the community level

3 hours



1. Ask participants if they have ever maintained the water supply scheme using locally made fittings. What are they? Record their responses.
2. Inform participants that they are now going to practice to make fittings that are commonly used in the water supply schemes.
3. Explain that for the practice, 5 stations are prepared and participants will be divided into 5 groups. Each group will be assigned to each station and there, with the instructions, participants are to practice to make the fittings while discussing with the group.
4. Also inform participants that each group will get 30 minutes time in each station for practice. After 30 minutes, participants are to move to next station and practice making other fittings at the station.
5. Inform participants, before going for the group activity, they will get important things to consider for all stations, and at each station there are instructions on how to make the joints that they should follow.
6. As per the instruction listed, demonstrate verbally or instruct on how to make a fitting. Also add the points to consider while making the fittings.
7. Divide participants into 5 groups and assign a station to each group and ask to practice making fittings as per the instructions at the station.
8. After the making of fittings, ask participants to store the fittings for further reference during the workshop.

Water Quality Test

60 minutes



1. Inform participants that one of the responsibilities of the water supply scheme is to maintain the water quality that is being provided to the community and provide safe water to the community.

Practicing Operation and Maintenance Skills

2. Ask participants what do they understand by safe water? Collect answer from the participants and explain further, safe water means the water is physically, chemically and microbiologically safe to use (or no physical, chemical and microbiological contamination).
3. Also inform that Government of Nepal has a guideline for the drinking water, NDWQS with 6-physical parameters, 19- chemical parameters and 2 microbial parameters.
4. Explain further with few common examples of each parameter.
 - a. Physical parameter: turbidity, color, taste and odor, total dissolved solids
 - b. Chemical parameters: Iron, Manganese, Chloride, Arsenic, Ammonia, Nitrate
 - c. Biological parameters: Total coliform or presence of any bacterial contamination

Trainer Note: Chemical contamination means the presence of chemicals more than it is marked in the NDWQS guideline

5. Further discuss with participants how to ensure the safe water and explain that safe water can be ensured by water quality testing.
6. Ask participants: "Does anyone have experience testing water quality? If so, can you tell us some details about how it is done?" Listen to 1-2 volunteers if they have such experience, and summarize their ideas.
7. Explain that for testing water quality, people usually need to take water to laboratories. Ask if anyone knows any laboratories nearby or if there is anywhere for water quality testing.
8. Collect ideas from participants and discuss further that most of the laboratories are concentrated in the urban areas and most of them being in Kathmandu, it is difficult to reach and afford at times. Also, explain that at times water should be tested as soon as possible or may need to be preserved, which adds to the difficulty in testing water quality.
9. Ask participants: "What could we do to make this water quality testing easier?"
10. Possible answer: If they could test water in the field by themselves it might be helpful.
11. Explain to participants that to resolve these issues, ENPHO has developed a field test kit that can be easily carried to the field and a person with simple guidance can use it to test water quality.
12. Ask participants: "Does anyone know about the ENPHO test kit or have you seen it before?"
13. If participants have seen it or heard about it, ask them to explain their experiences.
14. Present the ENPHO field test kit to the participants and explain that ENPHO field test is a simple cost-effective water testing kit developed for testing water quality in the field and can give approximate estimation of 10 common parameters of drinking water. These parameters are:
 - Coliform presence/ absence
 - Free residual chlorine
 - pH
 - Temperature
 - Ammonia

Practicing Operation and Maintenance Skills

- Iron
 - Nitrate
 - Phosphate
 - Chloride
 - Hardness
15. As part of the demonstration, show the different apparatus in the kit: ex. Vial, syringe, beaker, test-tube, dropper, wash bottle, holder, operational manual, etc.
16. Explain further about different reagents or chemicals in the test kit and demonstrate their use following the parameters as per the manual.
- Presence/ absence
 - Free residual chlorine
 - Iron
 - Ammonia

OR,

17. In absence of ENPHO field test kit, present the power-point slides of ENPHO field test kit and discuss further.

Review

15 minutes



1. Ask participants to reform into their earlier groups from the practical activity.
2. Ask participants to establish an exhibition stall by each group to show the fittings which they had made in practical session.
3. Request each group to describe to the large group about a fitting that they made from their first station.

Reflection of the lesson

Instructions to make fittings

Things to consider during joining HDP pipes

- Cut the edge of the pipe in desired angle
- File the edge of the pipe for smooth surface
- After filing the edge make sure not to touch the edges with anything else
- Match the edges of the pipe one wish to join and check for the difference between pipes diameter. Maximum difference should be 5 mm.
- Heat the heating plate and mark heating plate with thermochrome chalk and look for the color change of the chalk from white to brown. If the color of the chalk changes its color in 3 seconds, heating plate is in 220 degree temperature, cover the plate with Teflon cover and if the time for change of color of the chalk is too quick or too slow do not join the pipe and make sure to maintain the heat before joining pipe.

Note: Temperature of the heating plate is the main thing to consider while joining HDP pipe

- With the Teflon covered heating plate heat the HDP pipes and make sure that around 3mm length from the edge of pipes is heated. Once heated well, bring the edges together and provide uniform force on both pipes and hold for sometime.
- Do not use water to cool down the joint.
- Make sure not to provide huge pressure while joining the pipes
- Check the joint by curving pipe a bit
- Make sure to check for the leakages due to water pressure

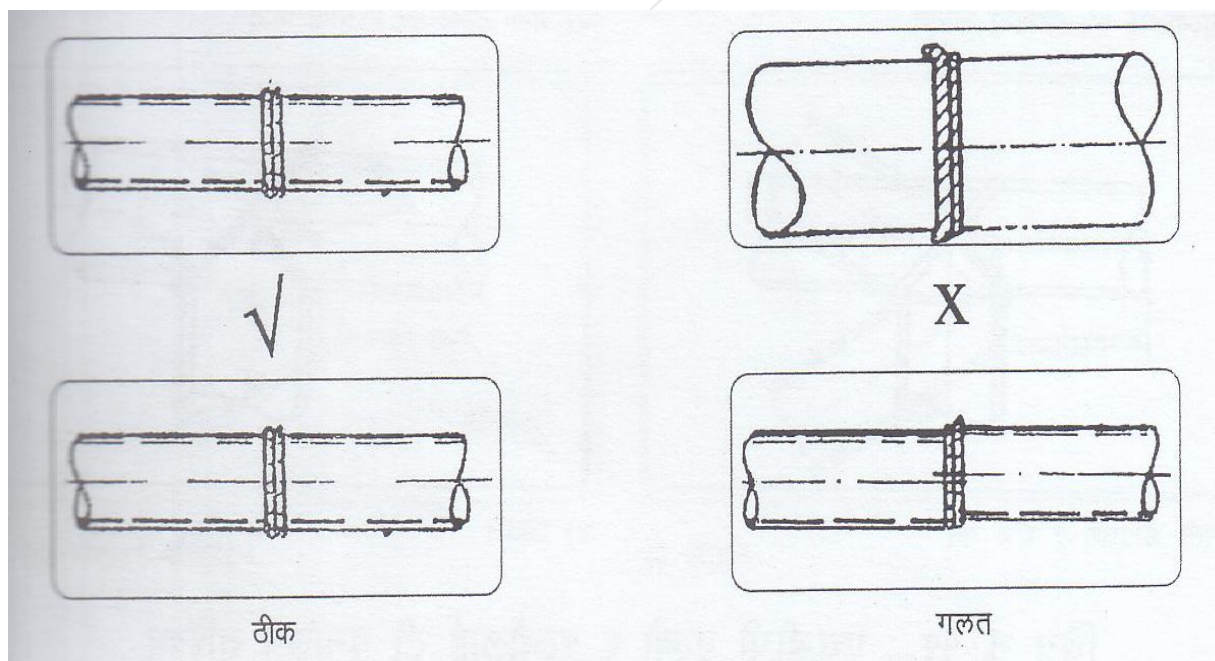

Elbow (L Shape)

- Cut HDP pipe in 45°, check for the measurement of the angle and make the interfaces of cut pipe smooth.
- Melt the interfaces of pipe by using heating plate (heating plate must be covered by Teflon Cover).
- Join the pipe together by applying the proper fusion force until the joint is cool.

एल्बो

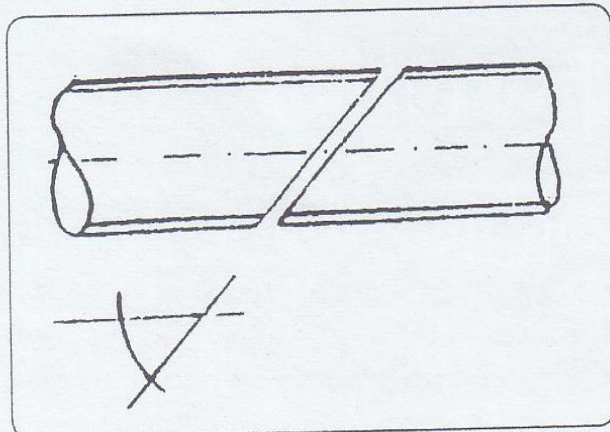

१) ४५ डिग्रीमा काट्ने

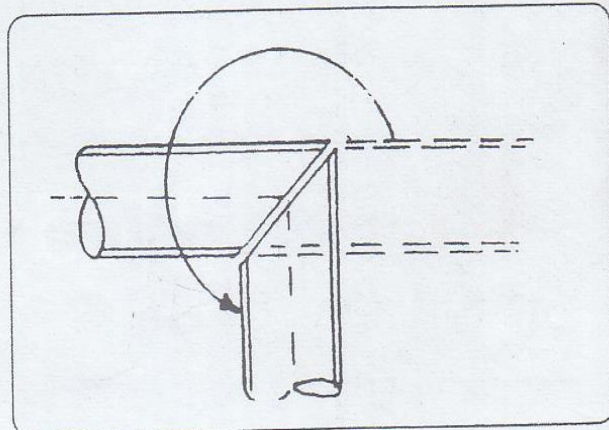

२) चेक गर्ने

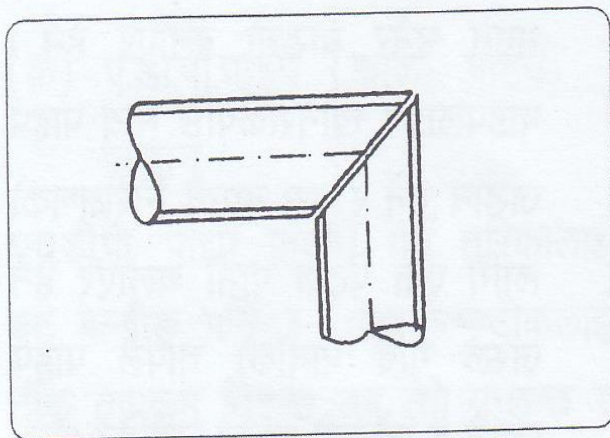

३) रेती लगाउने र चेक गर्ने

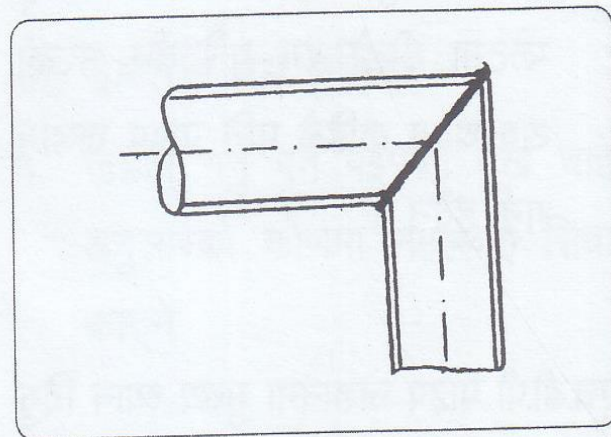

४) जोड्ने

HDP T Shape

- Cut both elbow (L Shape) and another piece of pipe in 45°.
- Use file (reti) to make the pipe edges clean and check the shape.
- Join the edges of pipes.

टी

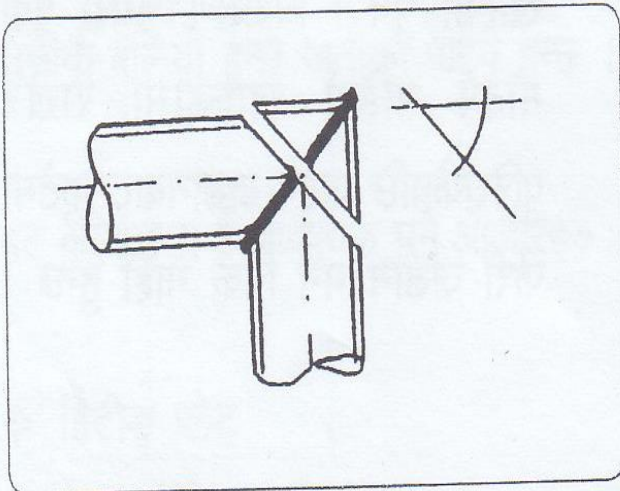

१) एल्बोलाई ४५ डिग्रीमा काट्ने

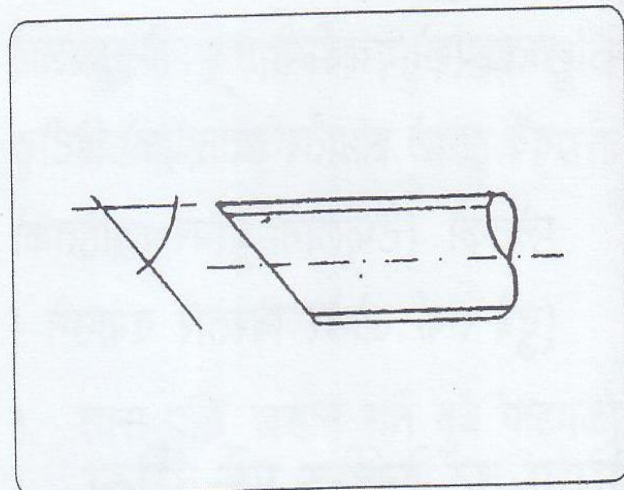

२) अर्को टुक्रा ४५ डिग्रीमा काट्ने

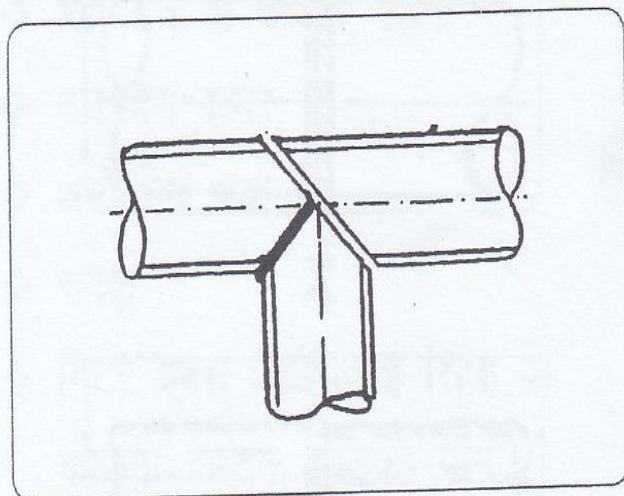

३) रेती लगाउने र चेक गर्ने

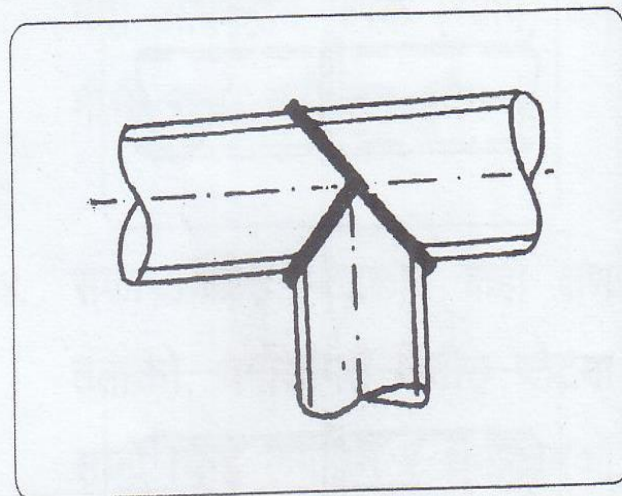

४) जोड्ने

HDP Y Shape

- Cut a pipe in 30° , file the edges, measure the angle and join the pipes.
- Cut the tip (pointing) part of the fitting in 60° and cut the other piece of pipe in 90° .
- Clean the edges of pipes and join the pipes using heating plate and join the pipes.

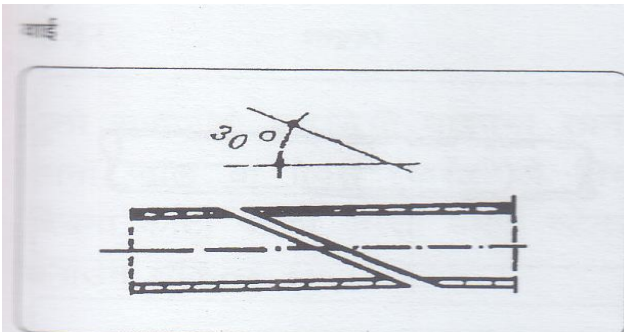

१) ३० डिग्रीमा काट्ने

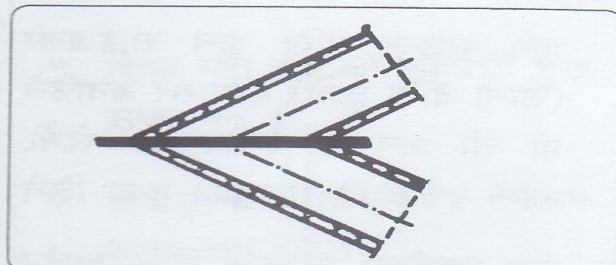

२) चेक गर्ने

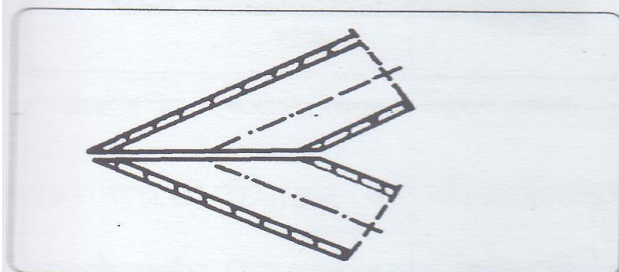

३) रेती लगाउने र चेक गर्ने

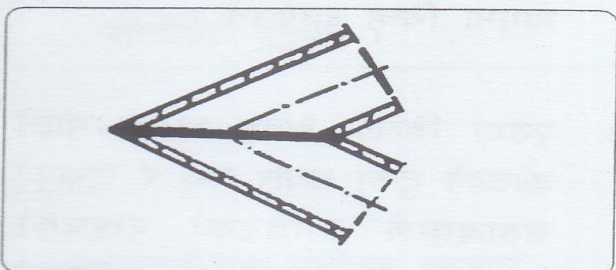

४) जोड्ने

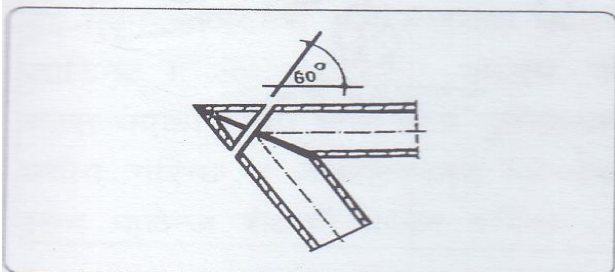

५) ६० डिग्रीमा काट्ने

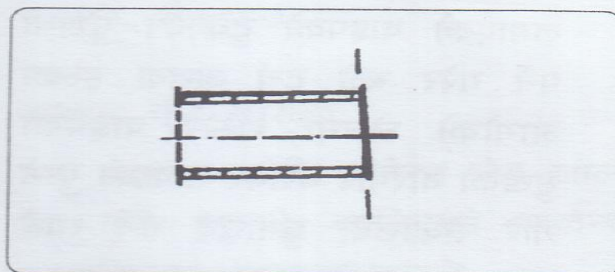

६) अर्को टुक्रालाई पनि काट्ने

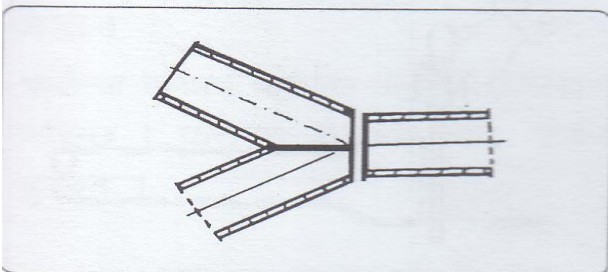

७) रेती लगाउने र काट्ने

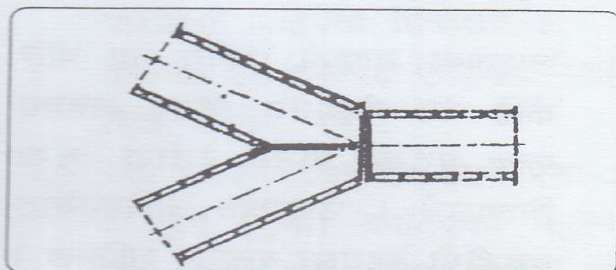

८) जोड्ने

Reducer

- Take around 20 cm long HDP pipe as per the reducer one needs to make (choose the smaller diameter which can be expanded to the larger one)
- Cut the pipe straight and file for the smooth surface
- Take a smooth surface wooden rod to expand the heated surface of the pipe
- With the help of blow torch heat 4 inches at one end of the pipe (where one wish to expand)
- While heating the end of the pipe on blow torch, slowly rotate the pipe while pushing to expand with the help of the wooden piece (make sure to rotate the pipe in uniform)
- Measure if the diameter is of desired size or not, if no, repeat the process and cool the pipe for a while.
- File for the smooth surface once again and the reducer is ready to use

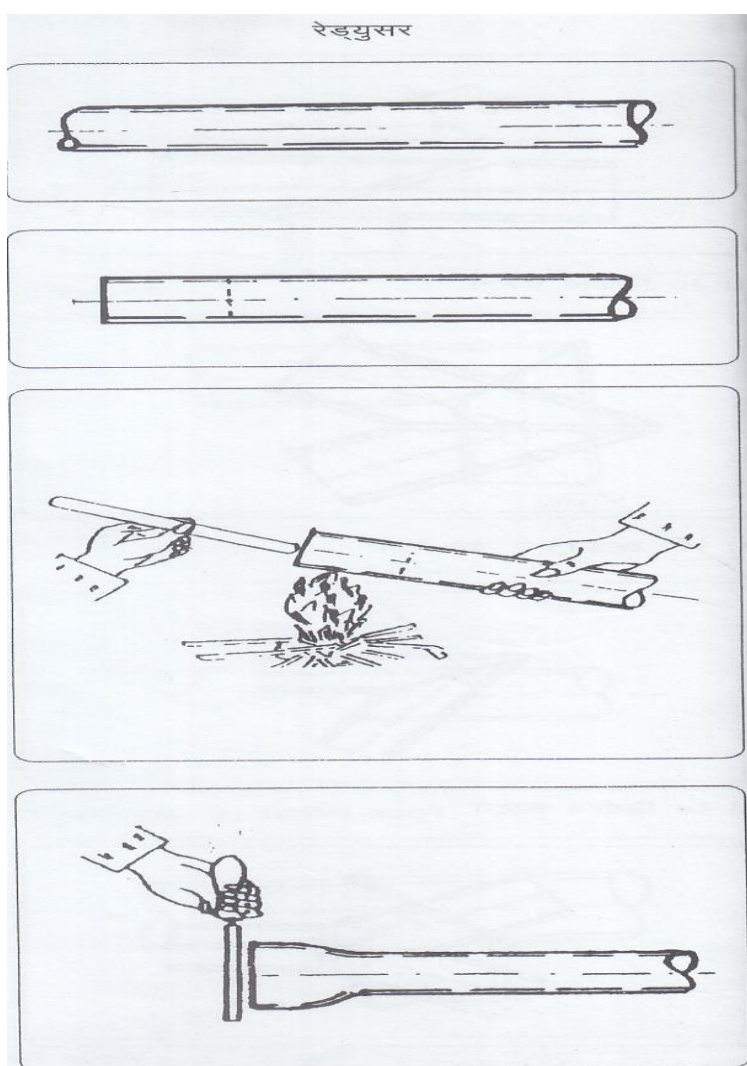

Practicing Operation and Maintenance Skills

Name of tools	Function
Hammer	It helps to break the stone or connect things together
Sharp edge hammer (<i>Tuktuke</i>)	It helps to cut stone
Chisel (<i>chhino</i>)	It breaks and cuts stone
Slope gauge (Batame)	It help to check the inclination of wooden frames (door frame)
Slope gauge (<i>Ghanti</i>)	It help to maintain vertical slopes
Level (Spirit level)	It maintains the surface level
Measuring tape	Takes measurements
Tray (<i>Karahi</i>)	Manage the amount of sand and stone; also carry the mixture
Hack-saw	It cuts pipe and metal rods
Heating plate	It help to adjoin two pipes
Blow torch	Provides heat (in absence of blow torch, wood stoves can be used)
Pipe wrench	It helps to handle pipe and tighten pieces
File	Smooths surfaces which are rough or uneven
Plier	Cuts and handles wire
Thread cutter	Makes thread on GI pipe
Teflon cover	Covers the heating plate
Thermochrom chalk	Check heat while heating the heating plate
Spinner	Tightens screw s
Slide/Adjustable wrench	Tightens screw and brass unions
Pipe vice	Clips GI pipe while making thread on it
Spade	To put on mixture of cement, sand, stone and make plaster
Finishing spade	To put on mixture of cement, sand, stone and make plaster
Shovel (<i>Belacha</i>)	To prepare the mixture of cement, sand, stone

Making threads in GI pipe

- a. Fix pipe vice in an appropriate place and manage the dissection of the pipe vice as per the diameter of the pipe
- b. Insert the GI pipe and hold it in the dissection of the pipe vice.
- c. Cut threads using thread cutter. Use appropriate teeth according to the size of pipe.
- d. Check the threads using socket or other fittings.
- e. Cut necessary number of threads.



Tools and Functions



Cut Cards - Tools used in Water Supply Schemes

Fittings used in Water Supply Schemes

Hammer	Measuring tape	File	Slide/Adjustable wrench
Sharp edge hammer(<i>Tuktuke</i>)	Tray (<i>Karahi</i>)	Pliers	Pipe vice
Chisel (<i>chhino</i>)	Hack-saw	Thread cutter	Spade (<i>Karni</i>)
Slope gauge (<i>Batame</i>)	Heating plate	Teflon cover	Finishing spade (<i>karni</i>)
Slope gauge (<i>Ghanti</i>)	Blow torch	Thermochrom chalk	Shovel (<i>Belacha</i>)
Spirit level	Pipe wrench	Spinner	Slide/Adjustable wrench

S.N.	Pictures	Name	Functions	Where does it fit
------	----------	------	-----------	-------------------

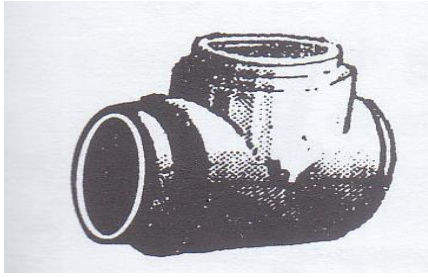
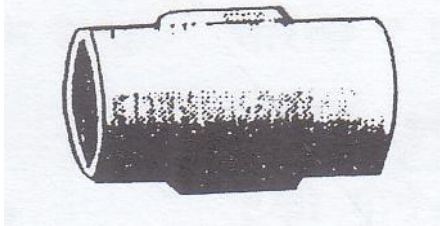
Practicing Operation and Maintenance Skills

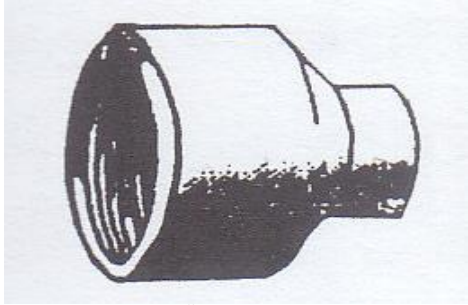
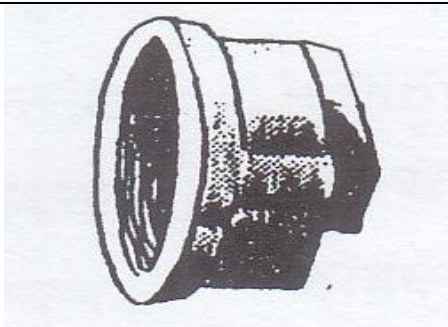
Set- 1				
1.		Equal T	<ul style="list-style-type: none"> Water distribution from same size of pipe to same another 	<ul style="list-style-type: none"> Distribution pipe line.
2.		Socket	<ul style="list-style-type: none"> To join the pipes 	<ul style="list-style-type: none"> Main line and distribution pipe line
3.		Elbow	<ul style="list-style-type: none"> To join the pipes which needed to go on another direction 	<ul style="list-style-type: none"> Main line and distribution pipe line
4.		Reducer	<ul style="list-style-type: none"> To send the water flow from the big pipe line to the small pipe line 	<ul style="list-style-type: none"> Main line and distribution pipe line
Set- 2				
5.		End plug	<ul style="list-style-type: none"> To cover the end point of pipes from which unwanted products can be thrown 	<ul style="list-style-type: none"> RVT Wash-out

Practicing Operation and Maintenance Skills

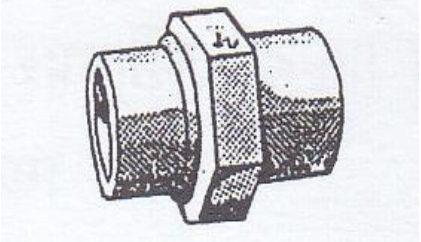
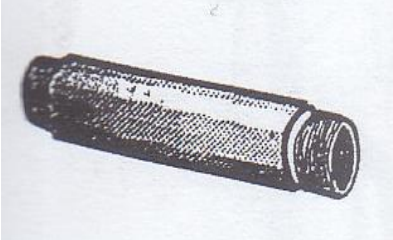
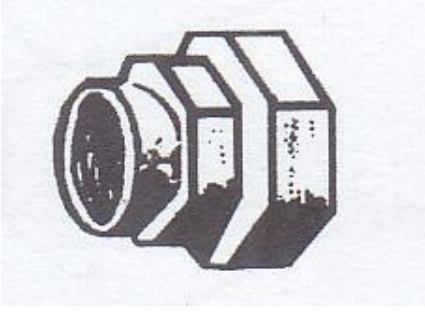
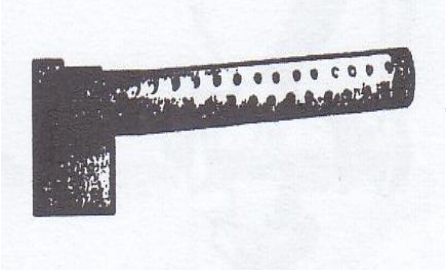
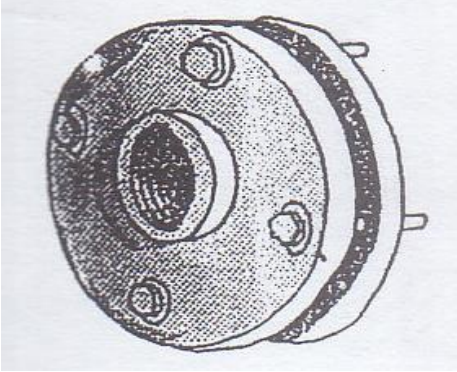
6.		Union	<ul style="list-style-type: none"> • Is to connect one pipe line to another pipe line 	<ul style="list-style-type: none"> • Main line and Distribution pipes
7.		Nipple	<ul style="list-style-type: none"> • Supply water where small size of pipe line is needed 	<ul style="list-style-type: none"> • Water services point and end plug services
8.		Brass union	<ul style="list-style-type: none"> • It's function is to connect the union (GI pipes and HDP pipes) 	<ul style="list-style-type: none"> • Main lines
Set- 3				
9.		Strainer	<ul style="list-style-type: none"> • It filters the water within the soil and dirt materials. 	<ul style="list-style-type: none"> • Between the source and main line.
10.		Flange set	<ul style="list-style-type: none"> • Is to connect the GI pipes and HDP pipes. 	<ul style="list-style-type: none"> • Distribution water pipes.

Practicing Operation and Maintenance Skills

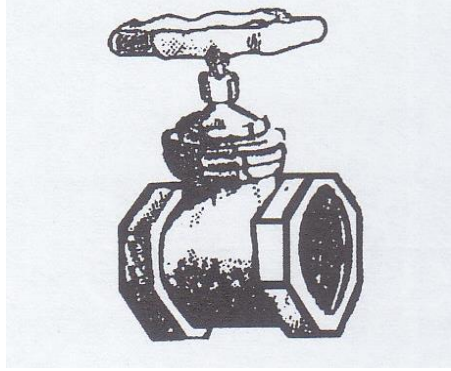
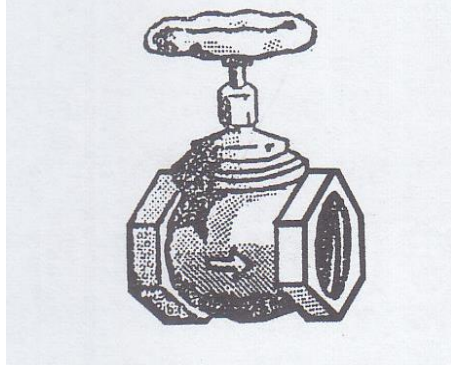
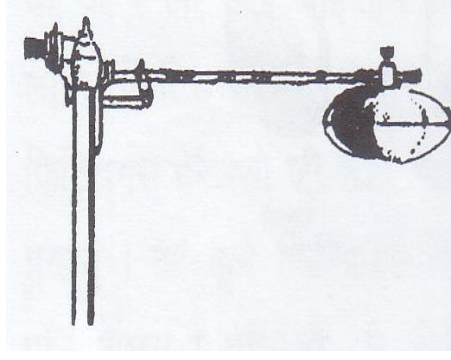
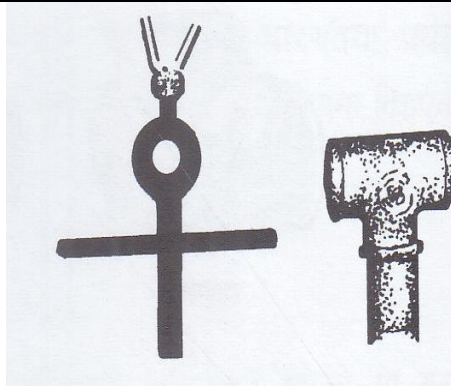
11.		Gate valve	<ul style="list-style-type: none"> • It is used to open or close the water in some places 	<ul style="list-style-type: none"> • BPT • Intake • Reservoir
12.		Global valve	<ul style="list-style-type: none"> • To maintain the flow of water • Also reduces the water pressure 	<ul style="list-style-type: none"> • Behind the water tap • Branch pipe • Inside the reservoir pipe
Set- 4				
13.		Float valve	<ul style="list-style-type: none"> • To control the flow of water 	<ul style="list-style-type: none"> • Reservoir • Tanker
14.		Flow regulatin g valve	<ul style="list-style-type: none"> • On the basis of population, it is used to drop the amount of water 	<ul style="list-style-type: none"> • It is placed at the front and back of the tap

Practicing Operation and Maintenance Skills

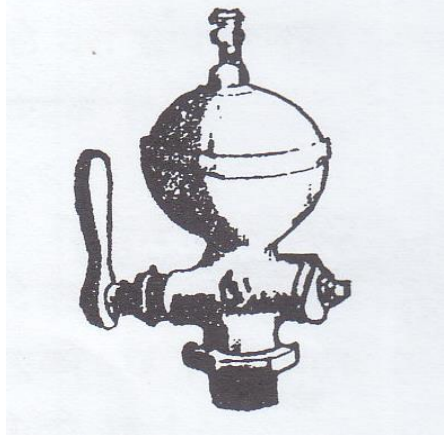
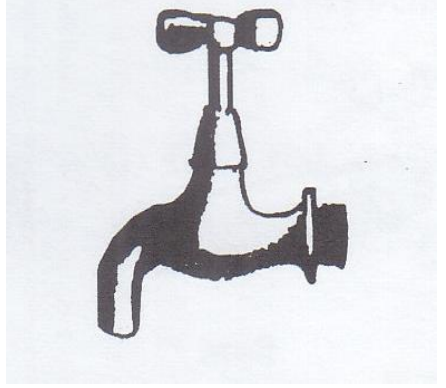
15.		Air valve	<ul style="list-style-type: none"> • It is used to remove the air from the pipe 	<ul style="list-style-type: none"> • It is placed at the top of the pipe line
16.		Tap	<ul style="list-style-type: none"> • Its function is to open or close the water services 	<ul style="list-style-type: none"> • At the end line of the water pipe where services are given

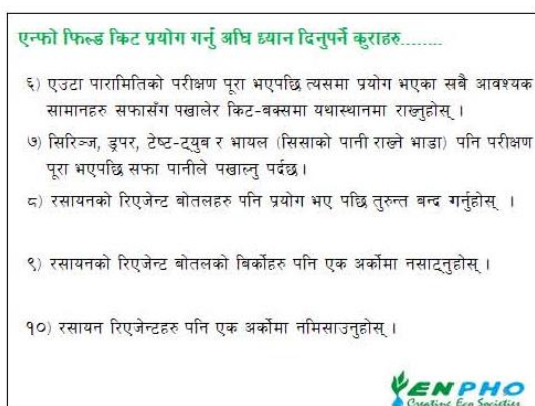
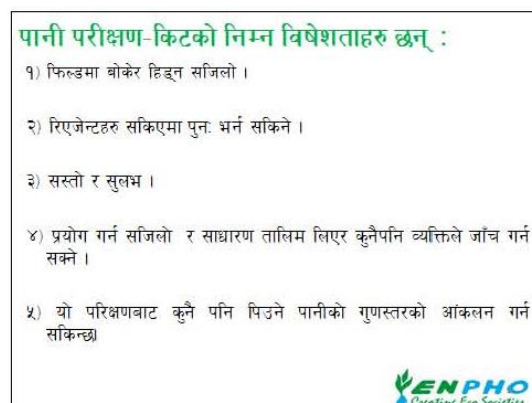
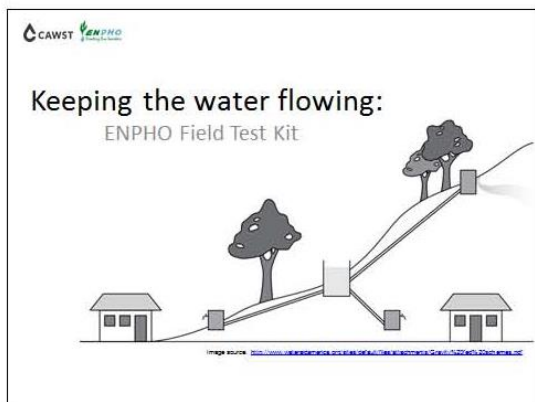

Lesson Plan 10: Workshop Review and Closing



Lesson Description



In the workshop closing, participants review what they learned and evaluate the workshop. The final closing is an opportunity to consolidate participants' learning, gather feedback and celebrate successes.

Learning Outcomes



At the end of this session participants will be able to:

1. Revise all workshop information.

Materials



- News print paper
- Tape
- Markers
- Sticky dots
- Self-evaluation sheet

Preparation



- Prepare stations by sticking topics of lesson plans on the wall for the review activity
- Print and cut the "Statements for Review Activity" points, or write them on individual pieces of paper (See end of lesson plan).
- Prepare flip chart with self-assessment from the workshop opening
- Prepare the flip chart paper with learning expectations
- Prepare a questionnaire sheet of the workshop evaluation

Workshop Review

20 minutes

1. Tell the participants that they are going for the review of the whole workshop. For this participants will be divided into pairs.
2. In their pairs, participants will get a set of five cards, with statements related to different lesson plans.
3. Around the room, topics of different lesson plans will be posted on the walls of the training hall. Discussing with their partner, participants will have to identify the topic of the lesson plan that the statement belongs to and paste it in the correct station.

Trainer note: Many statements might belong to different lesson plans, so participants will have to choose the topic where they think it fits best.

4. Once all instructions are clear, divide participants into pairs. Provide set of randomly divided cards to each pair and ask them to start the activity at once. (See end of lesson plan; you may wish to replace some based on discussions throughout the workshop).

Workshop Review and Closing

5. After all participants are done with the activity, review all the points in the large group or make sure all the cards are pasted correctly. Remember that some statements may be able to fit into several different locations.
6. Ask participants if there were any confusing statements while reviewing. If so, discuss briefly those points.

Revisiting Learning Expectations

5 minutes

1. Review the participants' learning expectation pasted on the flip chart at the beginning of workshop and discuss if all of them were addressed. If not, facilitator might answer some queries that participants might have or give recommendation of authentic sites to find the information they were looking for. Also identify further steps to follow-up with the participants.

Revisiting the Self-Assessment

5 minutes

1. Inform participants to return to the self-assessment chart which they performed at the beginning of the workshop.
2. Ask participants to place a new mark/sticky dots on the self-assessment chart to indicate their knowledge level after attaining the training on each topic.
3. Summarize result to the large group.

Evaluation sheet

10 minutes



1. Inform participants that they are going to evaluate the workshop and for this a final evaluation form has been prepared. Explain that their feedback will be addressed and help to updates the lessons. So, the more specific information/suggestion is expected and will be better.
2. Hand out the final evaluation forms to participants and inform them to fill and return the form before they leave the workshop.
3. If you plan to follow up through email, tell participants that a summary of the evaluations will be included in the final workshop report that will be mailed to everyone. Collect evaluations from participants before they leave the room.

Closing

5 to 20 minutes

1. Thanking all the participants for their active participation, inform them that the workshop is informally closed or close the workshop as per convenience.

Statements for review activity

Introduction to water supply schemes

Identifying the users
Conducting mass meetings
Forming user committees
Registering and renewing user committees
Air valve
Break pressure point (BPT)
Intake, Catchment and River crossing
Protection of water source / intake

Inform users about condition of the scheme

Supervise and support maintenance workers

Introduction to Operation and Maintenance

Running of a service or technology
Activities which keep a service in working condition
To keep the system sustainable
To improve quality of life and health
To ensure expenses are handled transparently
To keep the system functioning over time

Workshop Review and Closing

Operating Water Supply Schemes

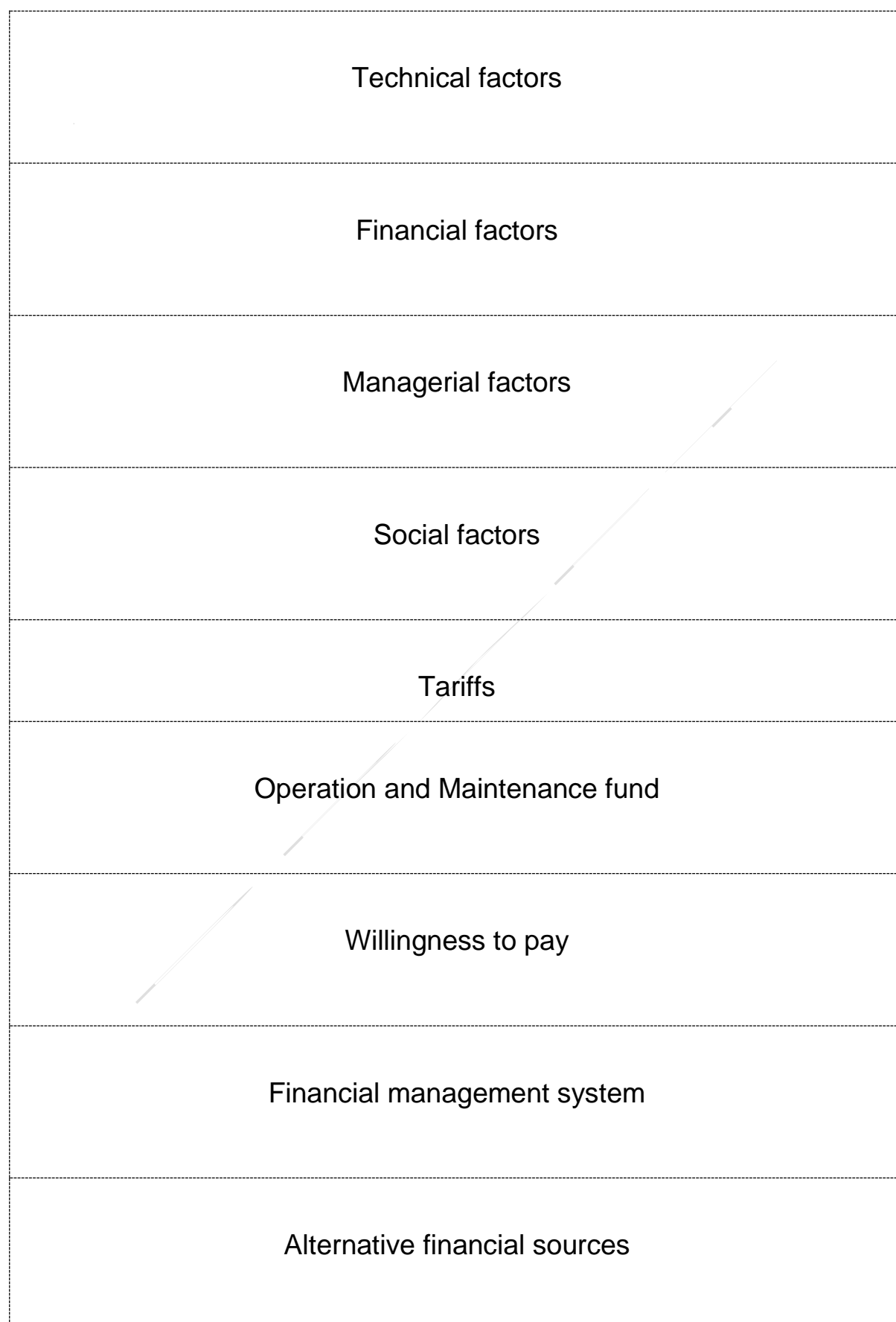

Day to day activities

Maintenance of water supply schemes

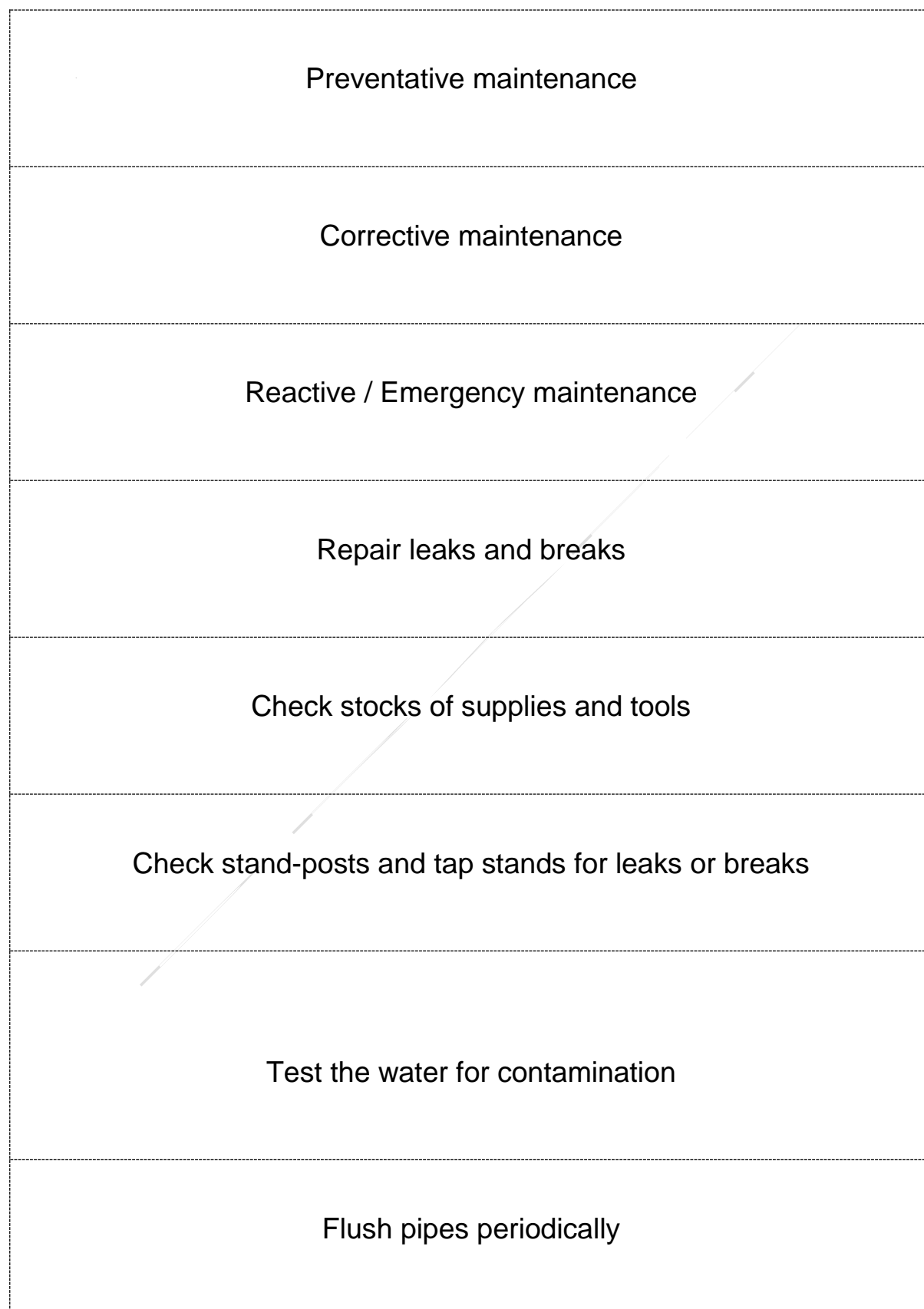

Workshop Review and Closing

Achieving O&M Objectives

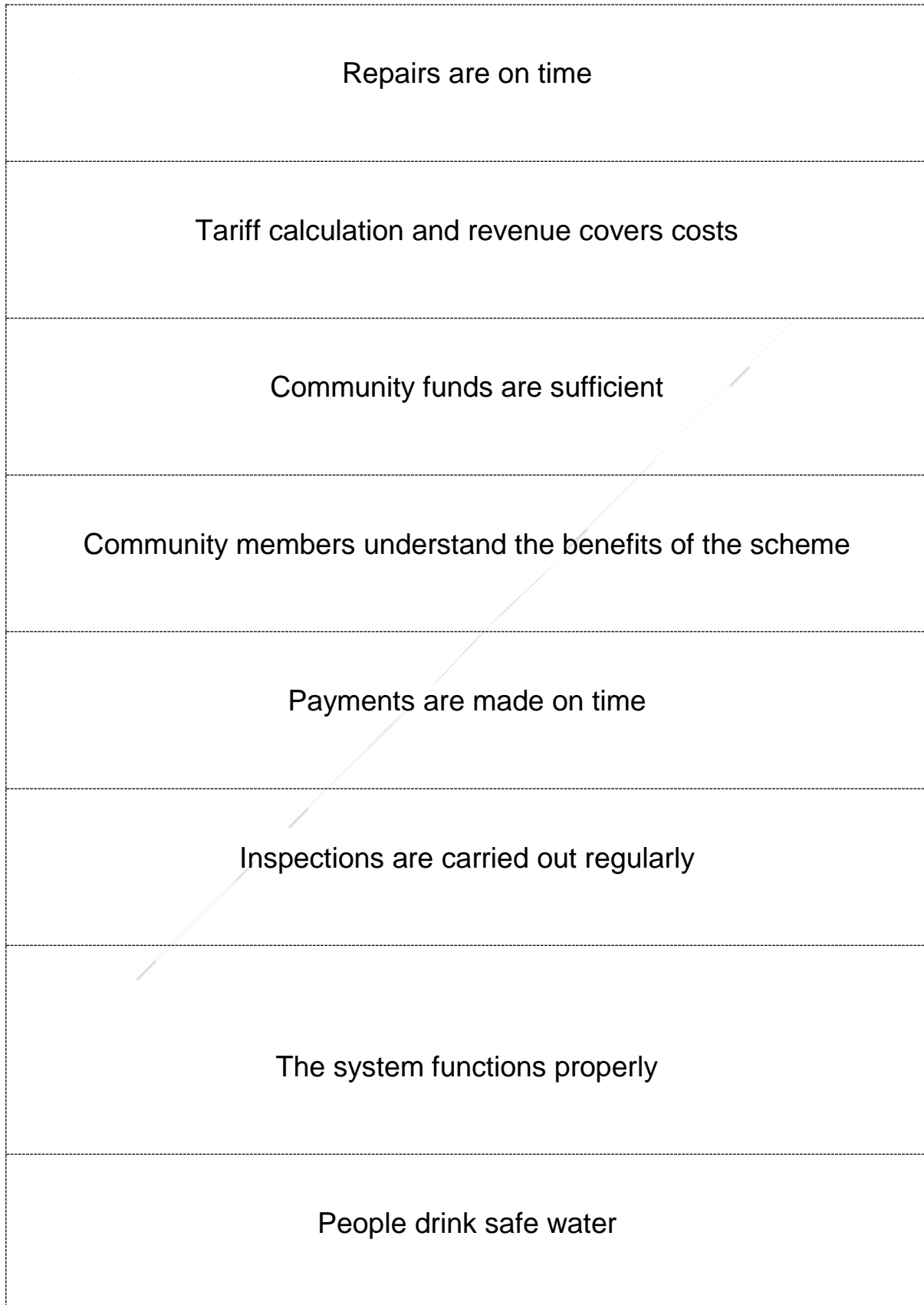

Workshop Review and Closing



Practicing operation and maintenance skills

ENPHO Field Test Kit
Chisel
Slope Gauge
Heating plate
Spade
Thread cutter
Elbow fitting
Gate valve

Float valve
Tap



Sustainability Planning

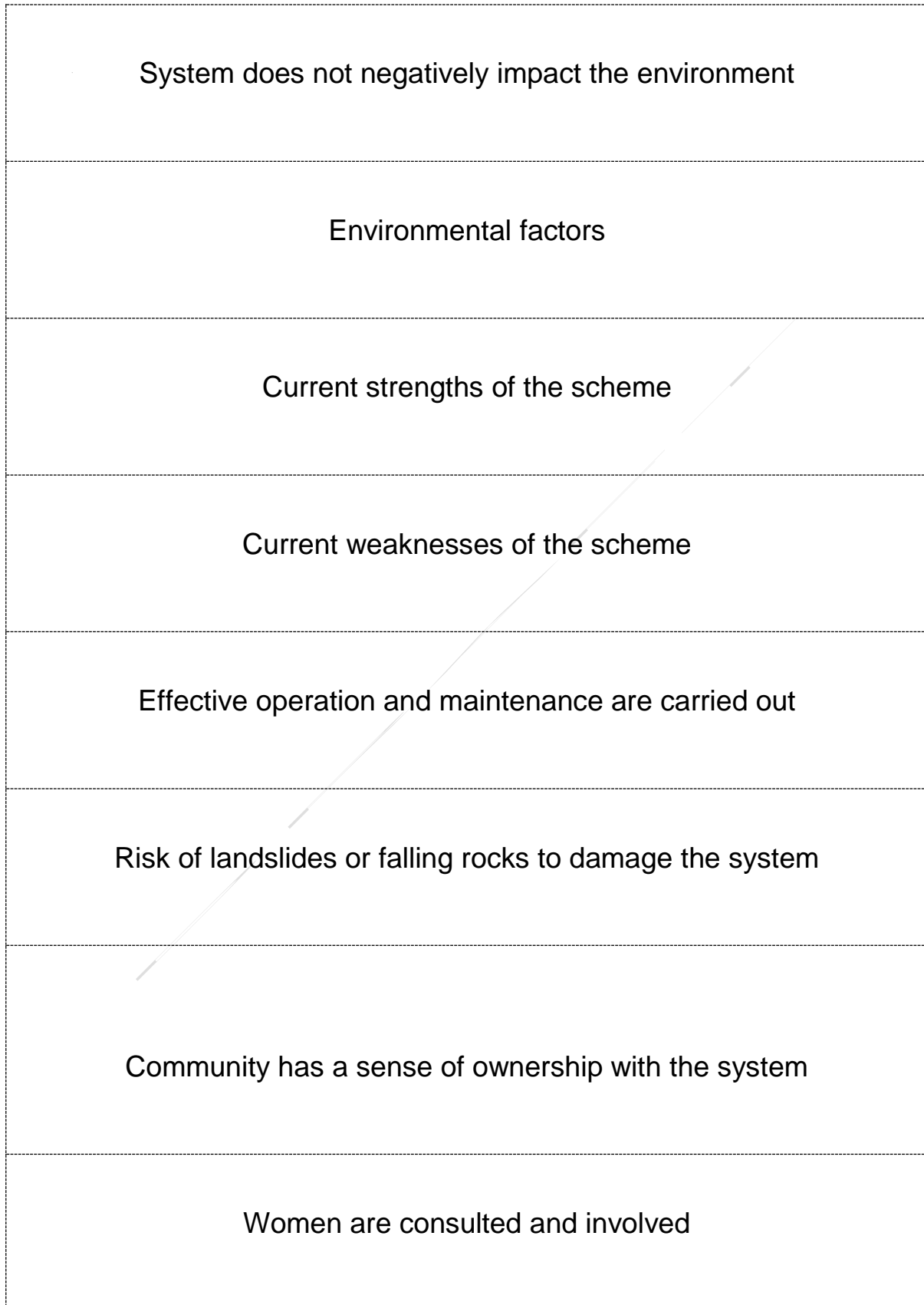

Regular meetings are held and issues are discussed

Solid waste and wastewater in the community are managed

Link to WASH



Proper hand washing with soap and water

Use of latrine

Lesson Plan: Day 1 Review
 **30 minutes**
Lesson Description

This lesson plan contains a morning review for day one of the workshop. The review activities allow participants an opportunity to practice what they learned the day before.

Learning Outcomes

At the end of each morning review, participants will be able to:

1. Recall information from the previous day.

Materials

- Flip chart paper
- Markers
- Tape

Preparation

- Prepare 3 flip charts with the following titles: “Introduction to water supply schemes,” “Introduction to operation and maintenance,” and “Operating water supply schemes.”

Day 2 Morning Review**20 minutes**

1. Ask the participants to form 3 groups.
2. Give each group a piece of flip chart paper with the titles “Introduction to water supply schemes,” “Introduction to operation and maintenance,” and “Operation and maintenance of water supply schemes.”
3. Tell the groups that you want them to write down the key information they remember for their topic from previous day’s lessons. They can refer to any notes they may have written or handouts they received.
4. After 5 minutes have each group present their flip chart with key information to the large group.
5. Discuss as a large group and add any key information missing.

Reflections on Lesson

Lesson Plan: Day 2 Review**15 minutes****Lesson Description**

This lesson plan contains a morning review for day two of the workshop. The review activities allow participants an opportunity to practice what they learned the day before.

Learning Outcomes

At the end of each morning review, participants will be able to:

1. Recall information from the previous day

Materials

- Ball

Preparation

- Prepare the questions for the review activity

Day 3 Morning Review**15 minutes**

1. Ask the participants to stand in a circle.
2. Inform participants, in the circle facilitator ask a question from earlier day sessions and passes a ball to a participant which he/she has to answer.
3. Also inform participant, if the participant could answer the question correctly than he/she decides next participant to ask question and passes ball to him/ her. If he/she could not answer, ball will be passed to the facilitator and facilitator decides the other participant to answer next question.
 - a. **Trainer note:** Make sure the ball is not passed repeatedly to a participant and others get equal chance to answer.
4. If possible, give chance to all participants to answer question.
5. Summarize the ideas and conclude the review activity.

Reflections on Lesson

Review questions

1. What do you mean by maintenance?
2. What do you mean by operation?
3. What is difference between operation and maintenance?
4. How many types of operation and maintenance are there and what are they?
5. Name 2 challenges faced during operation and maintenance
6. How many factors are there that affects operation and maintenance?
7. Name 2 activities under financial factor.
8. Name 2 activities under technical factor.
9. Name 2 activities under managerial factor.
10. Name 2 activities under social factor.
11. What is the other factors affecting sustainability other than the 4 main factors and how does it affect sustainability?
12. Describe the WASH acronym
13. Explain the link between improved WASH and water supply schemes
14. Explain disease transmission routes.